

LA-3910

c. 1

LOS ALAMOS SCIENTIFIC LABORATORY
of the
University of California
LOS ALAMOS • NEW MEXICO

**A Study of Selected
Criticality-Dosimetry Methods**



FOR REFERENCE

NOT TO BE TAKEN FROM THIS ROOM

NO. 1935

LIBRARY BUREAU

UNITED STATES
ATOMIC ENERGY COMMISSION
CONTRACT W-7405-ENG. 36

LEGAL NOTICE

This report was prepared as an account of Government sponsored work. Neither the United States, nor the Commission, nor any person acting on behalf of the Commission:

A. Makes any warranty or representation, expressed or implied, with respect to the accuracy, completeness, or usefulness of the information contained in this report, or that the use of any information, apparatus, method, or process disclosed in this report may not infringe privately owned rights; or

B. Assumes any liabilities with respect to the use of, or for damages resulting from the use of any information, apparatus, method, or process disclosed in this report.

As used in the above, "person acting on behalf of the Commission" includes any employee or contractor of the Commission, or employee of such contractor, to the extent that such employee or contractor of the Commission, or employee of such contractor prepares, disseminates, or provides access to, any information pursuant to his employment or contract with the Commission, or his employment with such contractor.

This report expresses the opinions of the author or authors and does not necessarily reflect the opinions or views of the Los Alamos Scientific Laboratory.

Printed in the United States of America. Available from
Clearinghouse for Federal Scientific and Technical Information
National Bureau of Standards, U. S. Department of Commerce
Springfield, Virginia 22151

Price: Printed Copy \$3.00; Microfiche \$0.65

LA-3910
UC-41, HEALTH
AND SAFETY
TID-4500

LOS ALAMOS SCIENTIFIC LABORATORY
of the
University of California
LOS ALAMOS • NEW MEXICO

Report written: December 1967

Report distributed: June 14, 1968

A Study of Selected
Criticality-Dosimetry Methods

by

Dale E. Hankins

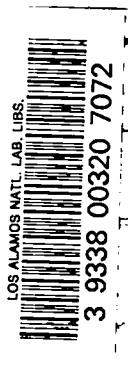

1
1
1
1

1
1
1
1

CONTENTS

	Page
Abstract	5
Introduction	5
Critical Assemblies	6
Jezebel Assembly	6
Hydro Assembly	7
Flattop Assembly	8
Parka Assembly	9
Godiva IV Assembly	9
Calculated Leakage-Neutron Spectra	11
Dosimetry Systems	11
Indium Foils	11
Film Badges	12
Thermoluminescent Dosimeters (TLD)	13
Sphere Neutron Detectors	13
Geiger Counter Reading at the Abdomen	13
Blood-Sodium Activation	13
Hurst Proportional Neutron Counter	14
Threshold Detector Units (TDU)	15
Positioning of the Phantoms, Dosimeters, and Instruments	17
Data Collecting Locations	18
Normalization of Results	20
Results	21
Hurst Proportional Neutron Counter and Threshold Detector Units	21
Nuclear Track Film	21
Thermal Neutron Dose from Film Badges, Gold Foils, and Lithium-Iodide Crystal	22
Multisphere Technique and 10-In.-Sphere Neutron Detector	24
Geiger Counter Readings at Abdomen and of Indium Foils	26
Sodium Activation	28
Thermoluminescent Dosimeters and Film Badges	28
Application of Results to Criticality Accidents	31
Early Screening of Potentially Exposed Persons	33
Geiger Counter Readings at Abdomen	33
Geiger Counter Readings of Indium Foil	35
Gamma-Ray Exposures	36

CONTENTS (Continued)

	Page
Neutron Dose from Nuclear Track Films	36
Thermal-Neutron Dose Determined by Film Badges and Gold Foils	37
Kerma Determination Using TDU Systems	38
Dose Equivalent Determined by 10-In. Sphere Neutron Detector	38
Dose Equivalent Determined by the Multisphere Technique	39
Blood Sodium Activation	39
Weight of the Exposed Person	41
Exposures Occurring at Unusual Locations or Positions	42
Exposures Occurring Near the Assembly	42
Orientation with Respect to the Critical System	42
Shielding by Hydrogenous Material	43
Shielding by Nonhydrogenous Material	43
Exposures with a Concrete Wall Behind the Plastic Man	43
Critical Assembly Distance above the Floor	44
Dosimetry Using Only Hair and Blood Activation	44
Conclusions	47
Acknowledgments	48
Appendix A.	
Probability of Neutron Capture by Sodium in the Body	48
Appendix B.	
Sodium Activity Induced in Various Segments of the Plastic Men	52
References	54

A STUDY OF SELECTED CRITICALITY-DOSIMETRY METHODS

by

Dale E. Hankins

ABSTRACT

Several methods for determining the dose received by persons accidentally exposed to a criticality excursion have been investigated. The dosimetry methods included use of film badges, thermoluminescent dosimeters, threshold detector units, Hurst proportional neutron counters, 10-in.-sphere neutron detectors, the multisphere technique, blood-sodium activation, and Geiger counter readings at the abdomen. Five critical assemblies with leakage spectra varying from a fast neutron spectrum to a highly moderated spectrum were studied. The effects of distance from the assembly, room scatter, shielding, and assembly height above the floor were investigated.

The results indicate that considerable information must be available before an accurate assessment of a person's dose can be made. If no information about the accident is available, dosimetry using a ratio of the hair and blood-sodium activation will give the dose to within ± 20 to 30% except where massive uranium or iron shielding occurs.

INTRODUCTION

The neutron activation of sodium in the body has been used to assist in determining the neutron dose received by the individual in criticality accidents.¹⁻⁸ A sample of the person's blood may be counted or, if the dose received was low, he may be placed in a whole-body counter to determine his blood-sodium activation.^{7,8}

Variations in the factor used to con-

vert blood-sodium activation to dose have been noted for different critical systems.⁶ These variations are caused by the capture cross section of the body which is approximately uniform for all neutron energies,⁹⁻¹¹ while the contribution of each neutron to the dose is a strong function of the neutron energy.¹² Consequently, after being exposed to a critical system whose leakage-neutron spectrum has a large component of thermal

TABLE I.
CALCULATED NEUTRON LEAKAGE
FOR THE CRITICAL ASSEMBLIES

Critical Assembly	Energy Interval	Relative Leakage Neutron in Energy Interval
Godiva	3 MeV-∞	0.1406
	1.4 - 3.0 MeV	0.2582
	0.9 - 1.4 MeV	0.1605
	0.4 - 0.9 MeV	0.2593
	0.1 - 0.4 MeV	0.1616
	17.0 -100.0 keV	0.0198
Parka	10.0 - 14.0 MeV	0.0004
	6.0 - 10.0 MeV	0.010
	4.2 - 6.0 MeV	0.018
	3.0 - 4.2 MeV	0.016
	2.1 - 3.0 MeV	0.049
	1.4 - 2.1 MeV	0.159
	0.9 - 1.4 MeV	0.151
	0.4 - 0.9 MeV	0.172
	0.1 - 0.4 MeV	0.247
	0.05- 0.1 MeV	0.178
Jezebel	3 MeV-∞	0.1897
	1.4 - 3.0 MeV	0.3003
	0.9 - 1.4 MeV	0.1695
	0.4 - 0.9 MeV	0.2090
	0.1 - 0.4 MeV	0.1151
	17.0 -100.0 keV	0.0164
Hydro with 9% enriched uranium exponential column (Super Kukla)	3 MeV-∞	0.045
	1.4 - 3.0 MeV	0.342
	0.9 - 1.4 MeV	0.303
	0.4 - 0.9 MeV	0.113
	0.1 - 0.4 MeV	0.127
	0 -100.0 keV	0.069
Flattop	3 MeV-∞	0.0218
	1.4 - 3.0 MeV	0.0363
	0.9 - 1.4 MeV	0.0513
	0.4 - 0.9 MeV	0.2405
	0.1 - 0.4 MeV	0.5404
	0 -100.0 keV	0.1096

neutrons, a person's blood-sodium activation may be several times greater than after being exposed to a system whose leakage-neutron spectrum is primarily in the fast-energy region.

Leakage neutrons from a given critical system have higher energy than neutrons from the same system that have been scattered from the floors and walls of a building. These room-return neutrons cause essentially the same blood-sodium activation per unit of fluence but contribute little to the dose.

We have studied the effects of different critical systems, room-return neutrons, distance from the system, geometry, and other parameters. The results of personnel dosimetry methods such as indium-foil readings, Geiger counter readings of the indi-

vidual's abdomen, and thermoluminescent dosimeter and film badge readings are also presented.

Plastic manikins filled with sodium solution were irradiated in various positions at different locations around the critical assemblies. Personnel dosimetry systems were placed on the plastic men for each irradiation. Several gamma and neutron dosimetry systems were used to determine the dose the plastic men received at each location.

CRITICAL ASSEMBLIES

Five of the critical assemblies at the Los Alamos Scientific Laboratory were used in this study. Their neutron-leakage spectra vary from a near-fission spectrum to a heavily moderated fission spectrum. The calculated neutron leakage (flux density) for each assembly is given in Table I. To convert the flux density to a leakage-neutron spectrum or flux spectrum, the calculated neutron leakage was divided by the difference in the logarithms of the upper and lower energies of the energy interval. For the interval 3 MeV to infinity, an upper energy of 6 MeV was used.

Jezebel Assembly. The Jezebel assembly^{13,14} was used extensively since it is the only portable assembly. Figure 1 shows Jezebel located outside the kiva (name given to the buildings used to house the assemblies at LASL) with the plastic men in position for an irradiation. Jezebel is the smallest unmoderated metal system of delta-phase ²³⁹Pu which will go critical. It is approximately spherical with a core diameter of about 6 in. The results were normalized to a given assembly power by activating sulfur pellets inside the "glory hole" of the assembly. This prevented activation of the sulfur by scattered neutrons when the assem-

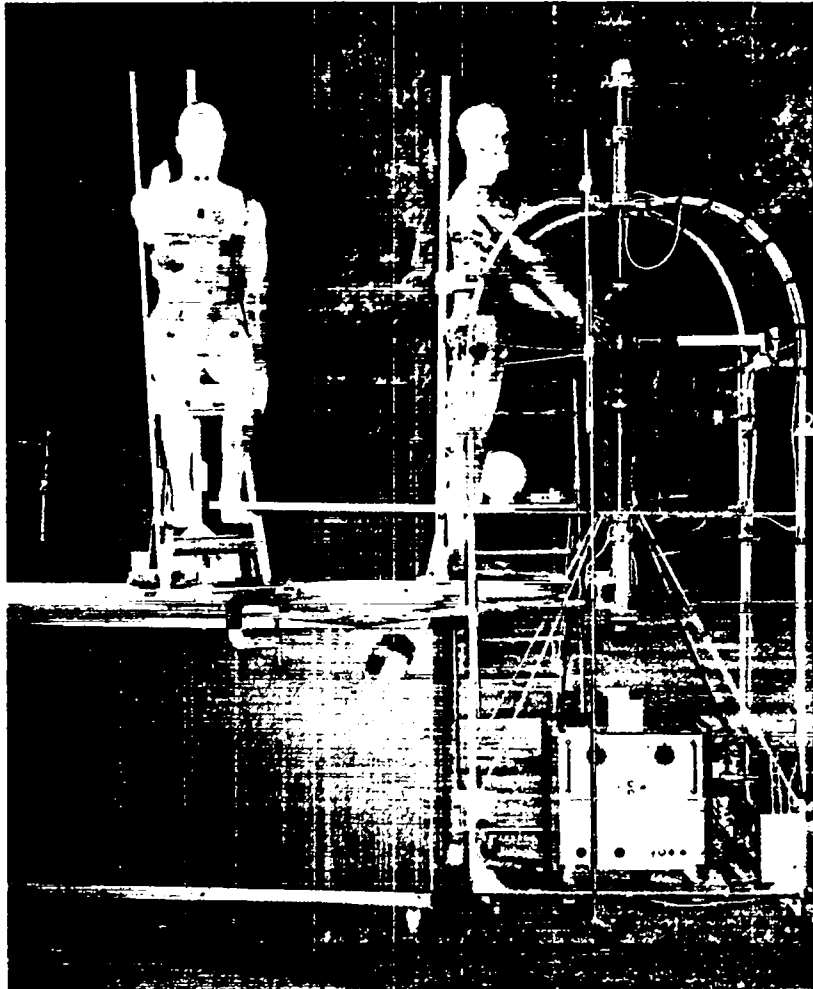

Fig. 1. Jezebel critical assembly outside the kiva with the plastic men in position for an irradiation.

bly was moved inside the kiva or when the plastic men were close to the assembly. The calculated leakage neutrons¹⁵ from the assembly are given in Table I, and the leakage-neutron spectrum is plotted in Fig. 2. The size of the Jezebel core is compared to the core sizes and geometry of the other assemblies in Fig. 3.

Hydro Assembly. Figure 4 shows the Hydro assembly,¹⁴ the only one permanently located outside a kiva. It is housed in a steel shed which is moved away during operation. It is used to study exponential piles such as the one shown in Figs. 3 and

4. To minimize the number of scattered neutrons around the assembly, it is elevated and located an appreciable distance from a kiva. Hydro has a neutron reflector of water, and the ^{235}U core is water-cooled. The geometry of the assembly and exponential pile (see Fig. 3) makes the leakage-neutron spectrum difficult to calculate. The calculated leakage-neutron spectrum in Table I is for the Super Kukla machine at Lawrence Radiation Laboratory (LRL), but it probably closely approximates the spectrum from the Hydro assembly and the uranium exponential pile. A plot of this spectrum is given in

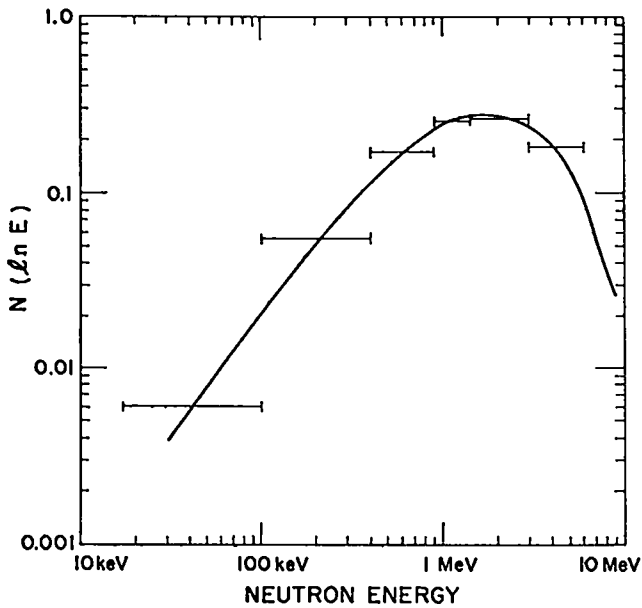

Fig. 2. Calculated leakage-neutron spectrum from the Jezebel assembly.

Fig. 5. The results were normalized to a given assembly power by placing sulfur pellets at fixed positions near the core and by using the BF_3 neutron counters which control the reactor power levels.

Flattop Assembly. The Flattop assembly¹⁴ can be operated with ^{238}Pu , ^{235}U , or ^{233}U cores. The 4-in.-diam cores are about the smallest masses of fissionable material which can be made to go critical in an unmoderated system. Flattop has a neutron reflector of about 7 in. of normal uranium. Fig. 6 shows the assembly; the schematic of the core and reflector is given in Fig. 3. The calculated leakage-neutron spectrum¹⁶ is given in Table I and plotted in Fig. 7. The leakage-neutron spectrum from this assembly has the lowest average

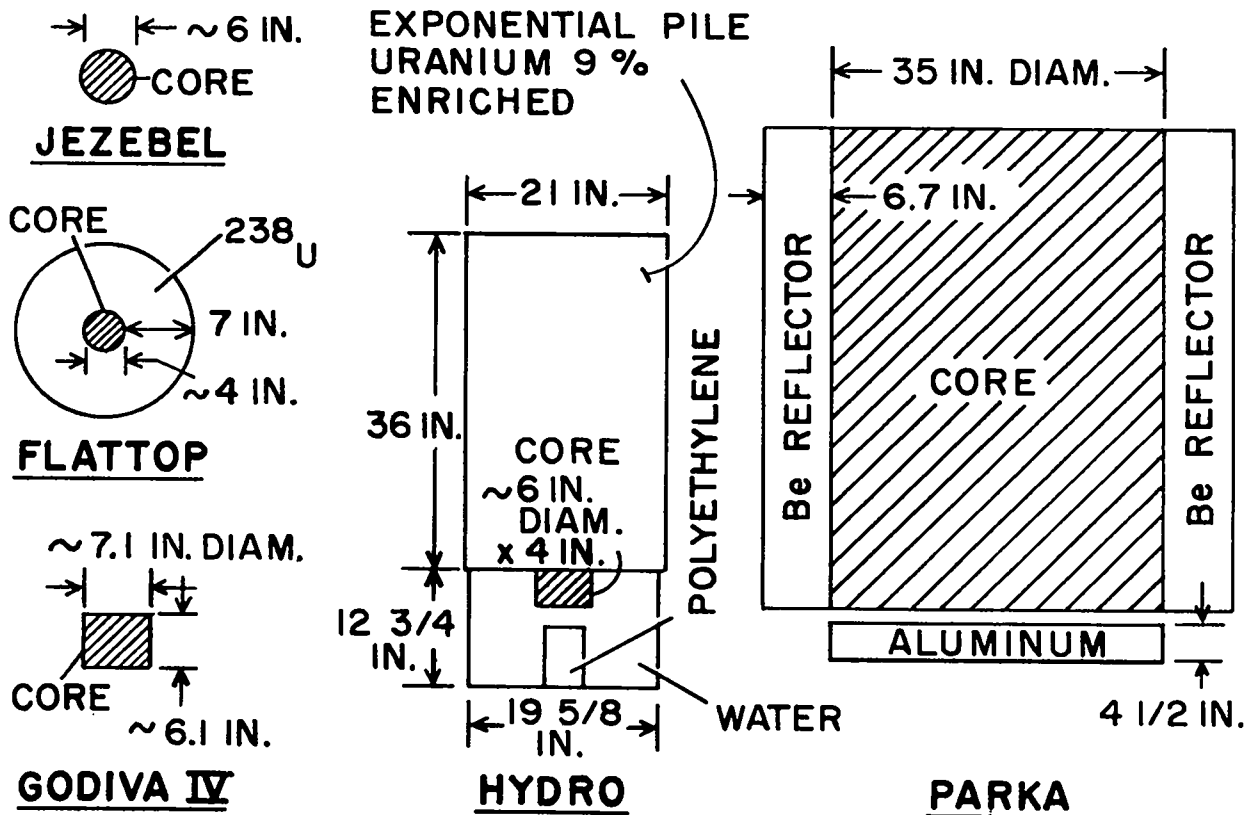

Fig. 3. The core configurations of the assemblies.

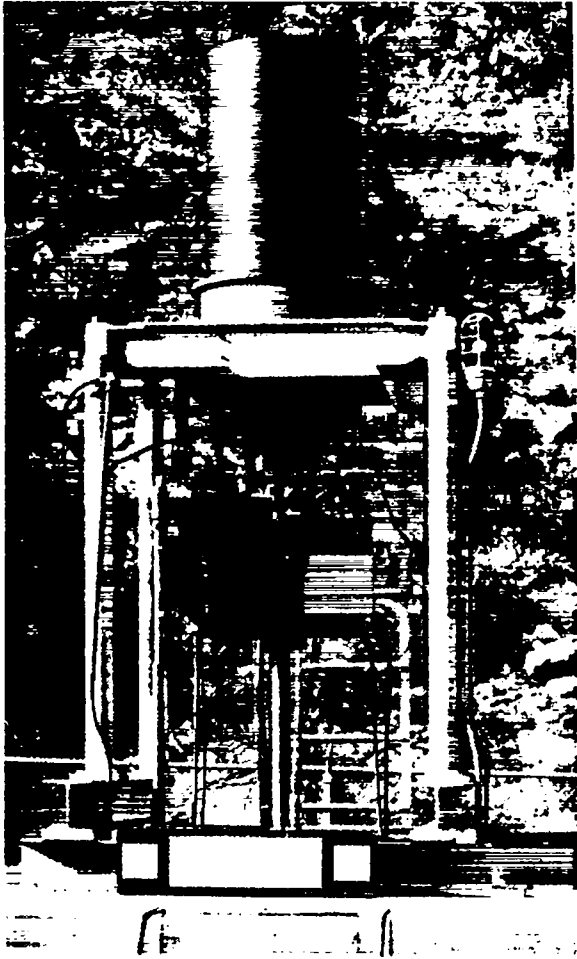

Fig. 4. The Hydro critical assembly with exponential pile.

fast-neutron energy of those from the five assemblies used, but it does not have a large intermediate and thermal component. The results were normalized to a given power by taping sulfur pellets at fixed positions on the outside of the reflector.

Parka Assembly. The Parka assembly¹⁴ shown in Fig. 8 is a Kiwi-type reactor and has the lowest-energy neutron spectrum of the assemblies studied. The core, as shown in Fig. 3, is much larger than that of the other assemblies. The core material is enriched uranium in graphite with a beryllium reflector. The calculated leakage-neutron spectrum¹⁷ from the side of the assembly is

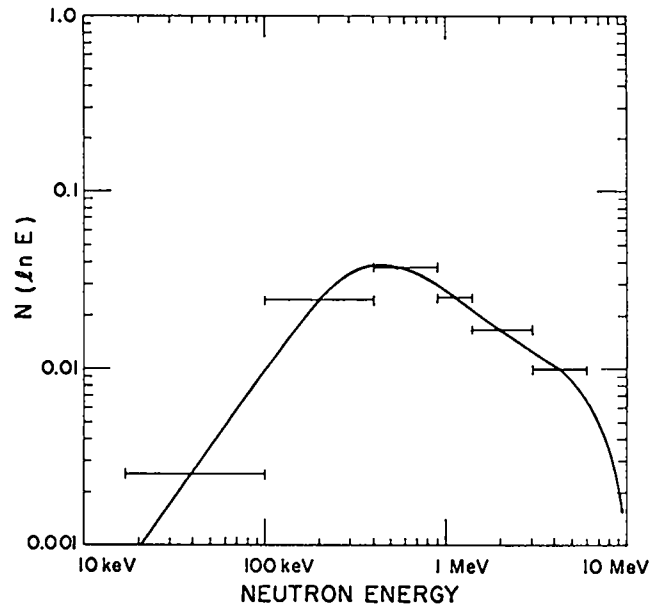

Fig. 5. Calculated leakage-neutron spectrum from the Hydro assembly.

given in Table I and plotted in Fig. 9. The leakage-neutron spectrum has a large component of intermediate and thermal neutrons as compared to those from the other assemblies. The results were normalized to a given power by placing sulfur pellets on the core and reflector.

Godiva IV Assembly. The Godiva IV assembly (Fig. 10) is the latest in the Godiva series. It is slightly larger than its pre-



Fig. 6. The Flattop critical assembly.

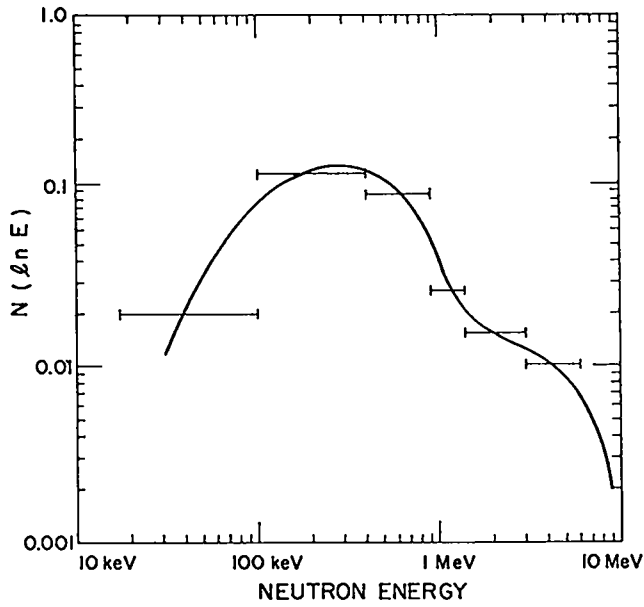

Fig. 7. Calculated leakage-neutron spectrum from the Flattop assembly.

decessors, and was designed to test a new concept for holding the core sections together and to give bursts having a narrow

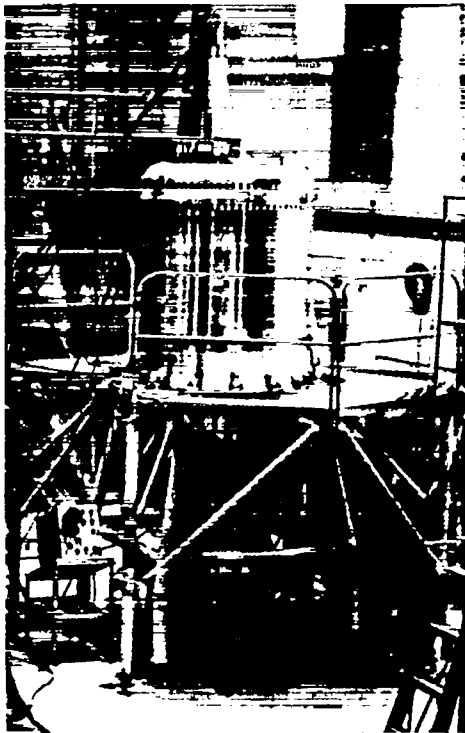

Fig. 8. The Parka critical assembly.

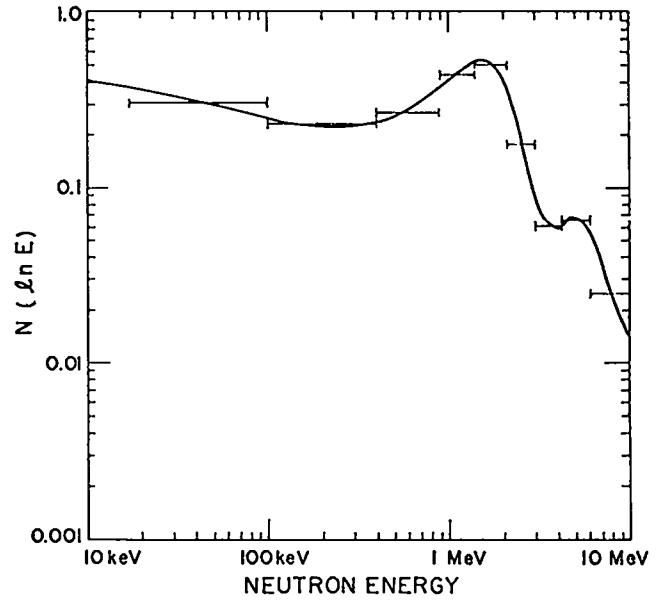

Fig. 9. Calculated leakage-neutron spectrum from the Parka assembly.

pulse width. The core of enriched uranium is shown in Fig. 3. This assembly was fab-

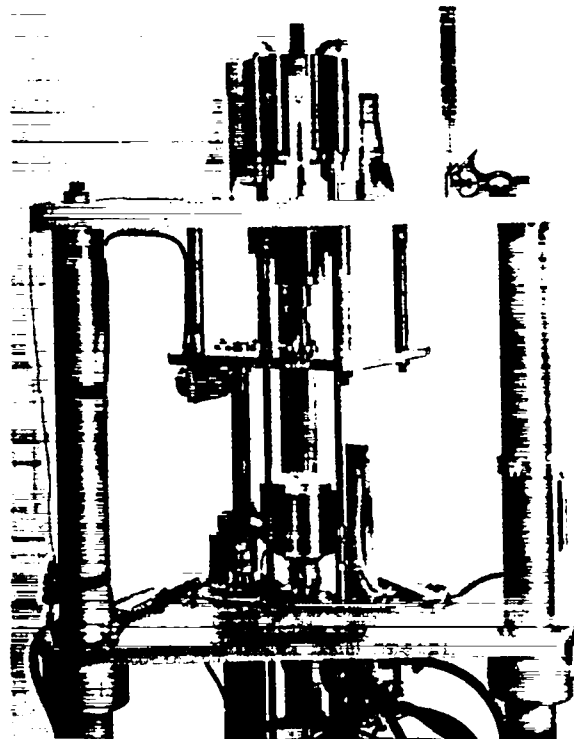

Fig. 10. The Godiva IV critical assembly.

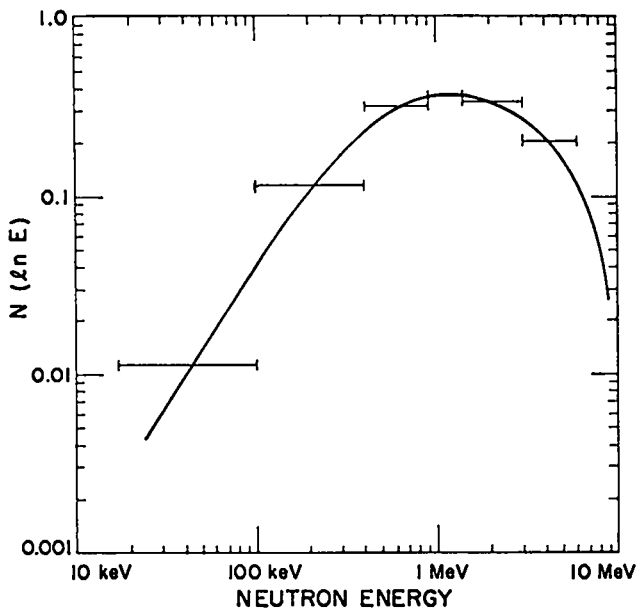

Fig. 11. Calculated leakage-neutron spectrum from the Godiva IV assembly.

ricated after most of the work described here was completed, and it was used primarily to ensure that the results of burst and long-term exposures could be compared. The calculated leakage-neutron spectrum¹⁶ given in Table I is for Godiva II; the Godiva IV spectrum has not yet been calculated but is expected to be very similar to that of Godiva II. The plot of the Godiva spectrum (Fig. 11) shows that it is only slightly softer than that of the Jezebel assembly. The results were normalized to a given power level by placing sulfur pellets at fixed locations on the assembly.

CALCULATED LEAKAGE-NEUTRON SPECTRA

The calculated leakage-neutron spectra from Table I are plotted together in Fig. 12 for comparison. The magnitudes of the spectra were adjusted until they were the same at 4 MeV. A progressive moderation can be seen, with Jezebel having the least-moderated spectrum followed by Godiva, Hydro, and Flattop. The Parka assembly has a more

complex leakage-neutron spectrum than the other assemblies. The spectra in Table I and Fig. 12 were calculated with large energy intervals and consequently lack detail. They are adequate for this study because even at small distances from the assembly (especially in the kivas) the spectrum changes rapidly. Frequently the leakage spectrum from a critical assembly or system is known and can be compared to the spectra given here, which permits the data in this report to be used for that assembly or system. If the spectrum is not known, the schematics in Fig. 3 can be compared to the type and geometry of the assembly in question and the spectrum for the most similar assembly can be used. Variations in the sodium activation and response of some of the dosimetry devices require that the spectrum be known or estimated as accurately as possible.

DOSIMETRY SYSTEMS

One objective was to determine variations in blood-sodium activation as the distance from the assemblies was changed, the neutron scattering varied, or different critical assemblies were used. We included several other dosimetry methods and systems in this study to determine the effect of these variables on their responses.

Indium Foils. A small indium foil is attached to the security badge of all LASL personnel working in areas with potential for a criticality excursion. These foils contain 1.0 gram of indium, measure about 1-1/2 x 4 cm, and are encased in transparent plastic. If a criticality accident occurs, the foil activity is determined using a Geiger counter at contact or 10 cm from the foil. These foils were designed for sorting personnel to determine who was exposed in a criticality accident and to find the relative magnitude of his dose. Soon these

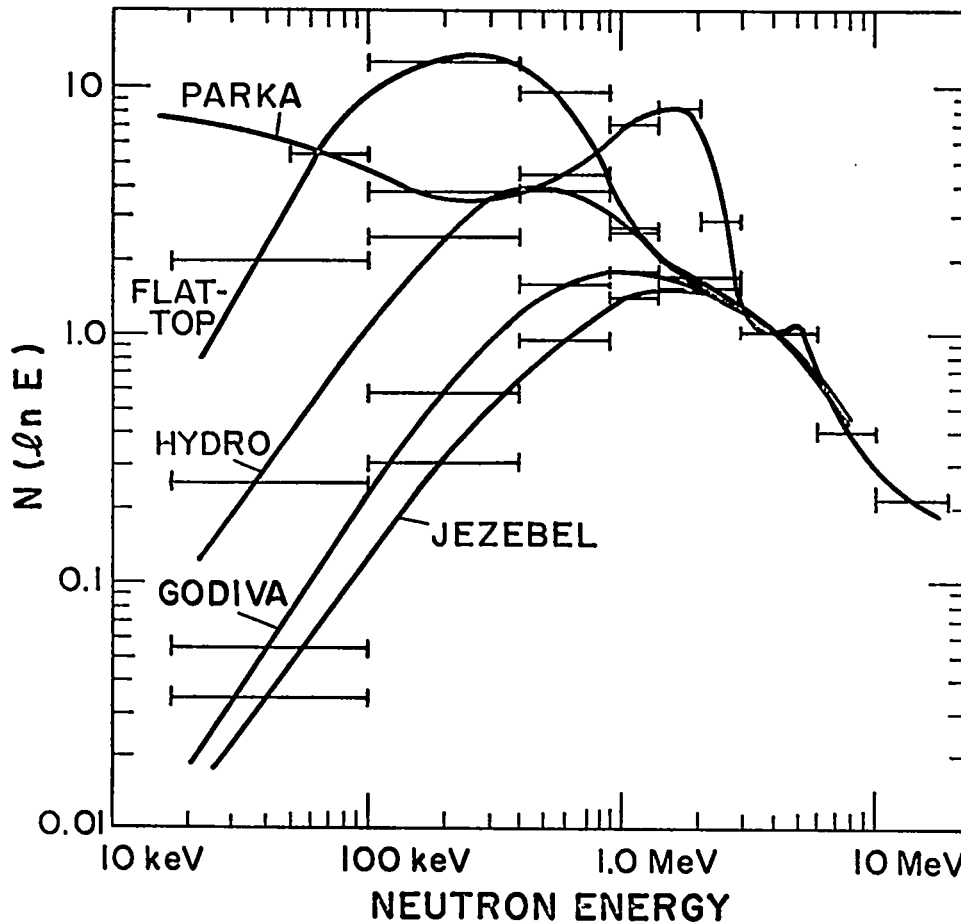

Fig. 12. Calculated leakage-neutron spectrum of critical assemblies normalized to 1.0 at 4 MeV.

foils will be replaced by a smaller foil (~ 0.2 gram, 12.5-mm diam) in a neutron dosimetry packet.¹⁸ The contact readings from the new foils will be only $\sim 22\%$ of that reported here (the Geiger counter reading is approximately proportional to the foil area).

Indium foils were taped on one side of the upper part of the breast of the plastic men. This is where the foil is worn by the person who clips his security badge to his shirt collar. We found that any location on the chest gave essentially the same reading. A foil was also placed on the back of the plastic man to simulate a person facing away from the critical system.

The induced activation was measured with a Geiger counter (closed shield) in contact with the foils. In many cases, as long as 4 hr. was required before the activity decayed to less than 20 mR/hr, the upper range of the counters used. All readings were corrected for decay to the mid-time of the irradiation.

Film Badges. The new Cycholac film badge¹⁹ being put into service at LASL was used. The Cycholac badge contains a DuPont-545 film packet with 555 component film and a Kodak Personal Neutron Monitoring Film, Type-B film packet, which contains the fine-grain positive film and NTA Type-B components. The film badges were placed on the

upper chest of the plastic men and in a corresponding position on their backs.

Thermoluminescent Dosimeters. A thermoluminescent dosimeter (TLD) system developed by EG&G, Inc.²⁰ was used. These were vacuum-tube-type CaF_2 dosimeters, in energy-compensating shields. They were placed near the film badge on the upper breast of the plastic men and in a corresponding position on their backs. The dosimeters were also exposed in air at each location studied.

Sphere Neutron Detectors. The multi-sphere neutron-monitoring technique²¹ data and the 10-in.-sphere neutron detector^{22,23} data were obtained with the same instruments. The data used to evaluate the capture cross section of sodium in man (Appendix A) were obtained with 2- and 8-in. spheres without the cadmium cover normally used. Eight critical assembly operations were required to collect the data for each position.

Three sphere-detector units were used concurrently, with the signals from the pre-amp or amplifiers being fed into a 100-channel Technical Measurements Corporation's gammascope analyzer or a 400 channel RIDL analyzer. Gamma-ray pile up created no problems. Lithium-iodide crystals, 4 x 4 mm and 4 x 8 mm, were used in the study. Secondary calibrations were performed before, during, and at the end of each day's work by taping a $^{238}\text{PuBe}$ source onto the 8-in. sphere. Primary calibration was with a larger $^{238}\text{PuBe}$ neutron source and a ^{252}Cf source 30 cm from the detector. Although the 30-cm calibration distance is small for the size of the spheres, we have found that the 8- and 10-in.-sphere instruments can be calibrated at a sphere-to-source distance of 20 cm to >2m. In spite of the complex geometry of the small sphere-to-source distance, the instrument response remains pro-

portional to the inverse-square relationship.²⁴

Since the sphere detectors are highly sensitive to neutrons, the assembly power had to be reduced to considerably under that required for other detector systems. Sphere data were normalized to data obtained with the other detector systems at higher assembly power levels by using BF_3 detectors with linear amplifiers. Also at least one of the following was used: Hurst proportional neutron detector, sphere neutron counters (at greater detector-to-critical-assembly distances), or sulfur pellet irradiations.

Data obtained using the sphere detector with a bare probe and with a cadmium-covered probe were used to determine the thermal-neutron dose.

Geiger Counter Reading at the Abdomen.

A reading was obtained with a Geiger counter held to the plastic man's abdomen. The highest reading was about midway between belt line and crotch while the plastic man was standing. This reading was made as soon as the man could be moved away from the assembly and placed in a low-background room, normally 30 to 50 minutes after the irradiation. No decay correction was applied except to the readings after the Godiva burst, when recovery of the plastic men was delayed about 2 hours. A correction based on ^{24}Na decay was applied to this reading.

Blood-Sodium Activation. The plastic men were filled with a solution of tap water, NaCl , and NaNO_3 . The tap water contained only a trace of sodium which resulted in <0.1% of the total solution activation. The solution was prepared by adding 262 grams of NaCl and 5490 grams of NaNO_3 to 106 liters of water to produce 108.6 liters with a sodium concentration of 14.62 mg/cc. This is 9.75 times the concentration of 1.5 mg/cc

of sodium in whole blood. Ten times blood sodium concentration was desired, but the increase in solution volume when the NaNO_3 was added resulted in the factor of 9.75. The Cl concentration was only approximately equal to that of blood, and, consequently, the Geiger counter readings at the abdomen are lower than those that would be obtained with a real person. A correction factor is given later in this report to compensate for the ^{36}Cl activity present in a person after irradiation.

Increasing the sodium concentration to 10 times that of whole blood was necessary to give reasonable activation of the solution without increasing the power levels of the assemblies. The sodium activation results given later have been corrected for this concentration factor. Increasing the assembly power levels would have produced radiation levels near the assemblies which would have prohibited recovery of the plastic men within a reasonable time.

To confirm that the sodium activation remains proportional to the concentration when the sodium concentration is increased to 10 times that of whole blood, bottles of various concentrations of the solution were exposed at two of the assemblies. With the Godiva assembly, for sodium concentrations up to seven times that of blood the activation was proportional to the concentration ($\pm 2\%$). With the Hydro assembly, the activation of a sodium concentration 10 times that of blood was low by less than 5% and sodium concentrations about 50 times the concentration of blood were low by $\sim 15\%$. Since the effect of concentration was small for concentrations up to 10 times that of blood, no correction was applied to the sodium-activation results.

The effect on solution activation of

TABLE II.

ACTIVATION OF SODIUM SOLUTIONS IRRADIATED IN A POLYETHYLENE-LINED CONTAINER AND AN UNLINED CONTAINER

Critical Assembly	Percent Change	
	6-in. Container Lined/Unlined	12-in. Container Lined/Unlined
Godiva	+ 9.3	+ 6.5
Plattop	+ 4.1	-
Parka	+ 5.3	-
Thermal neutrons from Water Boiler reactor	- 9.6	-

the lucite from which the plastic man is made was studied by exposing copper cylinders with and without a 0.125-in.-thick polyethylene liner. A similar study by Davy et al.²⁵ using the Health Physics Research reactor (HPRR) at Oak Ridge, found that for a 6-in.-diam cylinder 14-in. high the sodium activation in the lined container was 11% higher. Our results agree reasonably well (Table II). We have applied the correction factor for the 6-in. polyethylene-lined container to the results obtained with the plastic man. The error made by assuming that the plastic man has the same correction factor as the 6-in. container has not been evaluated. The results with the 12- and 6-in. containers are reasonably close, which indicates that for all parts of the plastic man, except the arms and lower legs, the correction factor is probably within 2% of the value we have applied.

Hurst Proportional Neutron Counter. A Hurst proportional neutron counter (HPC)^{1,26} made by Reuter-Stokes Electronics Components, Inc. was used to determine the first-collision dose. The detector was used with a Los Alamos Model-570 low-noise preamp and a Cosmic Radiation Laboratory Model-901-A linear amplifier. The data were recorded on a 100-channel Technical Measurements Corporation gamma-scope analyzer and were plotted by hand on semi-logarithmic paper with a

TABLE III.

EFFECTIVE CROSS SECTION FOR FISSION
FOILS IN A 1.65 G/CM ¹⁰B SHIELD AND
FOR SULFUR PELLETS

Assembly	Cross Section in Barns			
	Pu	Np	U	S
Jezebel	1.8	1.5	0.56	0.24
Godiva IV	1.8	1.4	0.55	0.24
Flattop	1.6	1.1	0.55	0.25
Parka	1.2	1.6	0.52	0.26
Hydro	1.6	1.2	0.55	0.25

straight-line extrapolation made to the zero-intercept channel of the analyzer. The integral area of the curve was then determined. The alpha calibrations were used only to check for gain changes in the electronics. Secondary calibrations were performed frequently with a ²³⁸PuBe source in contact with the top of the detector. Primary calibration was with a larger ²³⁸PuBe source 30 cm from the center of the detector. A value of 4.0×10^{-9} rad/n/cm² was used to convert the calculated neutron fluence at 30 cm from the source to rads.²⁷

Threshold Detector Units (TDU). The threshold detector system developed by Hurst et al.^{1,28} was used to determine the fast (kerma) and the thermal-neutron dose. The unit consists of plutonium, neptunium, and uranium fission foils in a ¹⁰B sphere, a sulfur pellet, and bare and cadmium-covered gold foils.

The fission foils were recovered as soon after the run as possible and counted. The decay from scram time to the beginning of the first count varied from 11 minutes to 47 minutes and averaged about 15 minutes. The foils were counted for 1 minute each, in series, until at least three counts with each foil were obtained. Blank foils of copper identical to that used to contain the fissionable material were irradiated and

counted at the same time as the fission foils. The fission-foil counter was calibrated by exposing equivalent foils¹ in the thermal-neutron flux of the Water Boiler reactor. Secondary calibration was with a ²²Na source. The fission-foil counter is similar to that described in Reference 1. The counts obtained with the fission foils were corrected for counter background and the activation of the blank foil. The background-corrected counts were then adjusted to give the count that would have existed 60 minutes after the mean time of the run. The counts were also adjusted to the count that would have been obtained with 1-gram foils.

A factor¹ was applied to the results to correct the fluence for the critical-assembly operating time which varied from 10 to 20 minutes. The results of the burst and continuous (referred to as D.C.) operations of the Godiva IV assembly indicate that the data from bursts and the longer irradiations can be compared accurately by using this correction factor.

The effective cross section of the sulfur pellets and of the fission foils (Table III) was determined for each critical assembly by weighting the cross section against the calculated leakage spectrum shown in Fig. 12. Perturbation corrections²⁹ were applied to the fission-foil data. The same weighting was used to find the effective dose per neutron. The values obtained are given in Table IV. Not all experimenters weight the effective cross section. In this study, we had available the calculated leakage spectrum for each of the assemblies which allowed us to refine our dose measurements by using effective cross-sections determined for each assembly. If the leakage spectrum is not known, a constant value for the effective cross section must be used;

TABLE V.

FACTORS TO CONVERT COUNTS PER MINUTE TO
NEUTRON FLUENCE FOR SEVERAL EFFECTIVE
CROSS SECTIONS

TABLE IV.
FLUENCE-TO-DOSE CONVERSION FACTOR^a

Assembly	Sulfur	Uranium- Sulfur	Neptunium- Uranium	Plutonium- Neptunium
	2.9 MeV	1.5 to 2.9 MeV	0.75 x 1.5 MeV	0.4 to 750 keV
Jezebel	4.5	3.3	2.3	1.44
Godiva IV	4.4	3.3	2.4	1.62
Flattop	4.4	3.2	2.4	1.10
Parka	4.6	3.1	2.5	0.98
Hydro	4.5	3.2	2.1	1.30

a. The values are times $\frac{10^{-7} \text{ ergs/g}}{n/\text{cm}^2}$.

however, the values which should be used have not been definitely established and vary at different laboratories. Although the effective cross sections we applied are valid only at the surface of the assembly, we feel that the weighted effective cross sections are more accurate than a constant value. Most experimenters weigh the effective dose per neutron to the leakage-neutron spectrum.

The effect of weighting the cross section to fit the calculated leakage spectrum from the assembly is illustrated by using the results obtained with the Parka assembly and applying the effective cross section for the Jezebel assembly. When this is done, the dose is reduced from 6.1 to 4.1 rad. If the weighted dose per neutron for Jezebel is applied to the Parka data, together with the weighted Jezebel cross section, the dose is reduced from 6.1 to 5.5 rad. The dose determined by using the HPC was 7.5 rad which agrees better with the results obtained by using the weighted cross sections and dose per neutron for the Parka assembly. Our experimental data have been included in the "Results" to permit a revised calculation of the dose if different effective cross sections are used.

The calibration factors used to con-

Cross Section (barns)	cpm	Cross Section (barns)	cpm
	10^{10} n/cm^2		10^{10} n/cm^2
Pu		Np	
1.8	4554	1.6	3870
1.6	4046	1.5	3628
1.2	3034	1.4	3385
		1.2	2660
		1.1	2902
S		S	
0.56	1370	0.26	965
0.55	1345	0.25	928
0.52	1272	0.24	891

vert the counts per minute (cpm) from 1-gram foils to fluence 60 minutes after exposure are given in Table V. Also shown is the factor used to convert the count rate from the sulfur pellets to fluence.

The sulfur pellets are 3/8-in. thick and 1-1/2-in. in diameter, pressed from analytical-grade sulfur. They were calibrated by exposing them to 2.5-MeV neutrons and by irradiating phosphorous pellets of the same diameter and thickness¹ with a known thermal-neutron flux in the Water Boiler reactor.³⁰ A cross section of 0.19 barns was used for the thermal-neutron capture by phosphorus pellets, and a cross section of 0.07 barns for the 2.5-MeV neutron capture by the sulfur pellets. The sulfur pellets and phosphorus pellets were counted using a thin plastic scintillator¹ mounted on a photomultiplier tube. A thin aluminum foil covered the scintillator to protect it from light. Each pellet was placed in a 1-mil-thick aluminum-foil dish, then positioned on the scintillator. A small lead disk was placed on the pellet to ensure uniform con-

tact with the scintillator. The pulses from the phototube were amplified and fed to a 100-channel TMC gamma-scope analyzer. The two calibrations agreed within 2%. Secondary calibrations were made frequently with a ^{90}Sr source. The sulfur pellets were normally counted ~ 24 hr after the irradiation, and were corrected for decay to the midtime of the assembly operation.

Two gold foils, one encased in cadmium, were exposed at each location. The foils were 1/2-in. in diameter and weighed about 0.63 gram. They were gamma-ray counted using the 3 x 3 in. NaI crystal and a 400-channel RIDL analyzer, available for routine health physics work at LASL. This equipment had been calibrated previously with thermal neutrons from the Water Boiler reactor using gold foils of the same diameter and weight.

POSITIONING OF THE PHANTOMS, DOSIMETERS, AND INSTRUMENTS

Two plastic men were available for the study, one with a skeleton, the other with plastic organs. The first irradiation with the Hydro assembly was used to check the effect of the skeleton on sodium activation. The results indicated that the plastic man with the skeleton had 3% greater sodium activation. Whenever possible, the plastic man with the skeleton was used for all irradiations within 3 meters of the assembly. For an irradiation involving both plastic men, the one with the skeleton was always closer to the assembly. The organs of the second plastic man were filled with solution. The lung cavities of both were empty. The plastic men were facing the assembly in a rigid standing position with both arms at their sides except where indicated otherwise. Irradiations with the side of the plastic man toward the assembly were made 3 meters

from Jezebel and Parka and 6 meters from Hydro.

The plastic-man-to-assembly distances were measured from the center of the abdominal cavity to the center of the assembly. This made the film badge, TDL, and indium foil which were placed on the man's back slightly farther away than the distance indicated. The distances between the assembly and the dosimeters on the plastic man's chest are greater than indicated when the man is close to the assembly because all distances were measured horizontally from the assembly to the center of the abdominal cavity. Farther from the assembly this effect becomes insignificant.

The dosimetry with the instruments and TDU's was performed at the assembly-to-detector distance indicated. Data were obtained at about 3-1/2 ft above the ground or platform used to elevate the plastic man.

The reproducibility of the sodium-activation results was determined by repeating irradiations of the plastic men at three locations several days after the first irradiation. The sodium-activation results of the first and second irradiations agreed within 1%, 2%, and 7%.

The plastic men are shown in Fig. 1. The one with the skeleton weighed 13.5 kg empty and 61.7 kg when filled with solution. The one with organs weighed 8.7 kg empty and 62.1 kg when filled with solution. A standard man weighs 70 kg, so these plastic men are somewhat smaller.

To simulate a heavier person, a polyethylene bag filled with 8 liters of solution was strapped to the front of the plastic men. A large bag was used to allow the contour of the solution to be similar to that of an overweight individual. The Jezebel, Hydro, and Parka assemblies were

TABLE VI.
IRRADIATION LOCATIONS

Critical Assembly	Distance from Assembly (meters)	Position of Plastic Men ^a
Jezebel (outside kiva)	0.5	Elevated 81 cm
	1.0	" " "
	2.0	" " "
	3.0	" 56 cm
	4.0	
	6.0	
	8.0	
	9.0	
	2.0	Behind plastic man at 1 m
	7.7	~30 cm from kiva wall
(inside kiva)	3.0	Elevated 56 cm
	3.0	Slant range to middle of man
	9.0	
(outside kiva, 90 cm from wall)	2.0	Lying on side, elevated 2 m
	3.0	Elevated 56 cm
	9.0	
Hydro	6.0	
	6.0	Two men side by side
	5.9	Elevated ~2 m
	8.7	
	12.3	
	16.2	
	19.8	~30 cm from thick concrete wall
Flattop	1.1	Elevated ~30 cm with one arm on platform
	3.0	
	6.1	
	~13	Shielded from reactor by concrete wall
Parka	3.0	Elevated 1.93 m
	3.0	Slant range to middle of man
Godiva IV (burst) (D.C.)	3.0	
	3.0	

a. Where a position is not indicated, the man was standing, arms at sides, facing the assembly.

used for this part of the study to give good coverage of the neutron spectra. The term "fat man" is used to describe these irradiations.

DATA COLLECTING LOCATIONS

Data were taken at a number of locations around the Jezebel assembly when it was outside the kiva, outside near the kiva wall, and inside the kiva. With Jezebel outside, data were taken at from 0.5 to 0.9 meters from the assembly. The locations are given in Table VI. The assembly is mounted with the core 2 meters above the ground. To avoid the effect of an angular exposure when the plastic men were moved close to the assembly (giving the head a larger dose), the men were elevated for these irradiations. One plastic man loca-

tion 2 meters from the assembly was behind the other plastic man placed 1 meter from the assembly. The sampling location at 7.7 meters was ~30 cm from the kiva wall and was included for study of the effect of backscattering from the wall.

Four locations were studied with the Jezebel assembly inside the kiva. To maintain a reasonable distance from the other assemblies in the kiva and prevent them from shielding our irradiation locations, the Jezebel assembly was placed as indicated in Fig. 13. Two irradiations were performed at the 3-meter location. The first was with the plastic man elevated 56 cm, a procedure similar to that used outside the kiva. For the second, the man was standing on the kiva floor. The term "slant range" used in Table VI indicates that the distance from the assembly to the plastic man was measured at an angle $>20^\circ$ from the horizontal.

For the last series of studies, the assembly was again moved outside the kiva. To study the effect of an excursion occurring close to a floor, the thick wall of the kiva was used to simulate the floor and the assembly was positioned with the core 90 cm from the wall. The plastic man was then placed horizontally on his side on a stretcher with his feet against the kiva wall. The stretcher was raised 2 meters (core height) and positioned 2 meters from the assembly. This arrangement approximates a man standing 2 meters from an assembly located 90 cm from the floor with a solid wall 2 meters to one side.

The effect of an excursion near a wall was studied by placing the Jezebel assembly 90 cm from the kiva wall and taking data with the assembly between the wall and the plastic men who were 3 and 9 meters from the assembly.

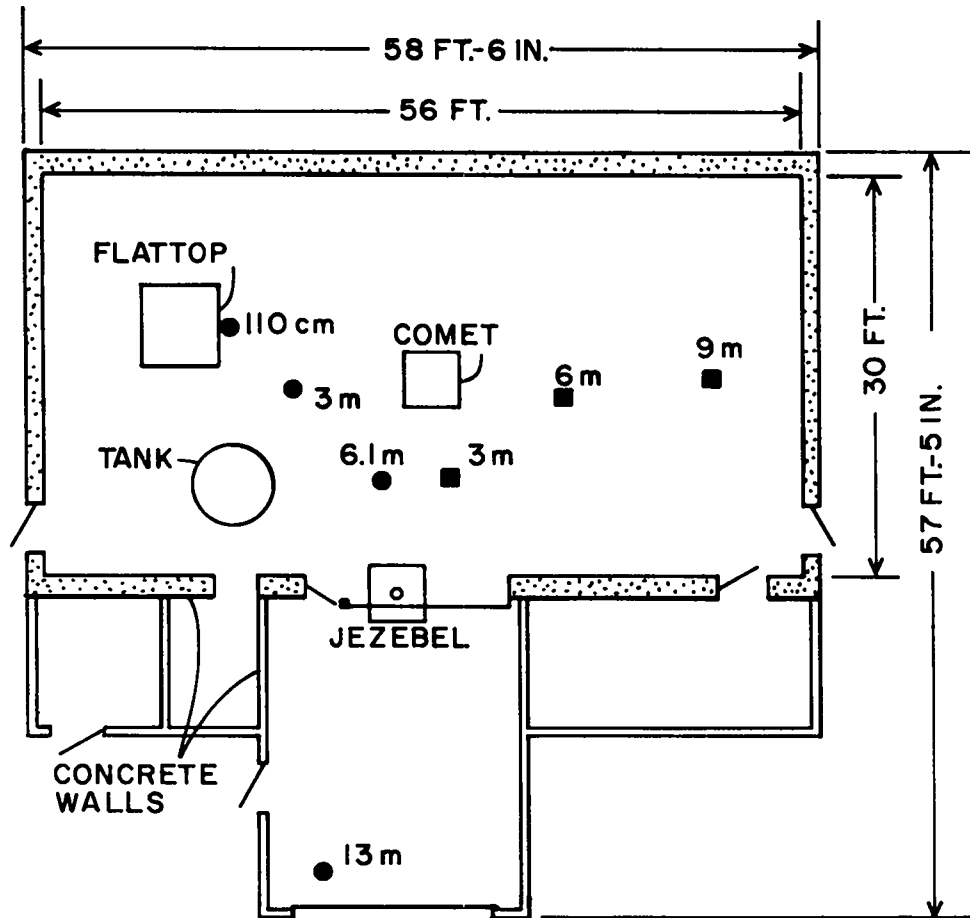

Fig. 13. Irradiation locations for Jezebel (■) and Flattop (●) inside kiva. (The Comet and Tank assemblies were not used in this study, and the Jezebel assembly was not in the kiva during the Flattop study.)

The geometry of the core, moderator, and exponential pile of the Hydro assembly is complicated. To avoid nonuniform irradiation of the plastic men from the core and exponential pile, the distances from the assembly to irradiation locations were large, varying from 5.9 to 19.8 meters. The core is about 3 meters above the ground, and, consequently, all assembly-to-irradiation distances given in Table VI are slant ranges except when the plastic man was elevated ~2 meters. For the first irradiation, the plastic men were placed side by side 6 meters from the assembly. This was to investigate the effect of the skeleton on sodium

activation and the effect of one phantom on the sodium activation of the other. One of the two positions at 19.8 meters had a concrete wall behind the man and was included to study the effect of neutrons scattered from this wall.

The Flattop assembly is located permanently inside the kiva. The irradiation locations are shown in Fig. 13. The plastic man at 110 cm (Table VI) was elevated to permit the lower right arm to be laid on the critical assembly platform (see Fig. 6). The location at ~13 meters has only room-scattered neutrons because it is completely shielded by the concrete walls of the kiva.

The Parka assembly is the only one studied which is located at another kiva. It was positioned near the center of the kiva. The plastic man was elevated 1.93 meters which placed him at the same height as the core (Table VI). His second location was on the floor, which resulted in an angle of about 45° from the core to the man. The neutron leakage from the bottom of the assembly differs only slightly from that through the sides.

The Godiva assembly was used for two operations, one a burst, the other 20 minutes long. The plastic man was standing on the floor 3 meters from the assembly.

NORMALIZATION OF RESULTS

The power levels of the critical assembly for each irradiation were determined as indicated in "Critical Assemblies." The data from the several irradiations required with each assembly were normalized to one of the irradiations. In most cases, the number of fissions was not determined or desired since the leakage spectra varied so greatly that a comparison of fissions and dose would be difficult to interpret.

We decided that the most meaningful comparison of the irradiation results from one assembly to those of the other four assemblies was the fast neutron dose. Two instruments described previously for determining the fast neutron dose were the threshold detectors which give kerma (in ergs/g) and the Hurst proportional neutron counter which gives the first-collision absorbed dose (in rads). The kerma in hectoergs/g determined by the TDU was used as the normalizing factor for the results. The hectoergs/g is 100 ergs/g which was selected to permit comparison with the rad determined with the HPC. Although the hectoergs/g and the rad

unit are both 100 ergs/g, the term rad is reserved for absorbed dose and cannot be used as the unit for kerma, see NBS Handbook 84.³¹ The neutron energies were low enough (<10 MeV) that we can assume that charged particle equilibrium exists in the HPC. When equilibrium exists, the first-collision absorbed dose in rads measured by the HPC is within a few percent of the kerma determined by the TDU and the two can be compared numerically with little error.

Normalization of the data from the five assemblies using the kerma determined with the threshold detectors does not include the thermal- and part of the intermediate-energy neutron dose and also is not a measure of the total absorbed dose. The factor to convert first-collision absorbed dose or kerma

TABLE VII.
FAST NEUTRON RESULTS OBTAINED WITH THRESHOLD
DETECTOR UNITS AND HURST PROPORTIONAL COUNTER

Critical Assembly	Distance from Assembly (meters)	Threshold Detector Units (hectoergs/g) ^b	Hurst Proportional Counter (rad)	Deviation of HPC from TDU (percent)
Jezebel (outside kiva)	0.5	460	460	0
	1.0	130	130	0
	2.0	35	37	+ 6
	3.0	18	17	- 6
	4.0	11	9.8	-11
	6.0	4.9	4.6	- 6
	8.0	2.8	2.7	- 4
	9.0	2.2	2.0	- 9
	2.0 ^a	6.4	5.8	- 9
	7.7 ^a	3.3	3.6	+ 9
(inside kiva)	3.0	19	20	+ 5
	3.0 ^a	21	21	0
	6.0	6.3	6.6	+ 5
	9.0	2.9	3.0	+ 3
(outside kiva, 90 cm from wall)	2.0 ^a	45	45	0
	3.0	20	20	0
	9.0	2.6	2.7	+ 4
Hydro	6.0	4.8	4.8	0
	6.0 ^a	4.3	4.8	+12
	5.9	4.8	6.0	+25
	8.7	2.2	2.5	+14
	12.3	1.3	1.5	+15
	16.2	0.69	0.83	+20
	19.8	0.49	0.58	+18
	19.8 ^a	0.63	0.66	+ 5
Flattop	1.1	33	29	-12
	3.0	4.9	4.3	-12
	6.1	1.6	1.5	- 6
	~13	-	0.077	-
Parka	3.0	6.1	7.5	+21
	3.0 ^a	4.2	5.8	+30
Godiva IV (burst) (D.C.)	3.0	127	-	-
	3.0	129	-	-

a. These data were obtained at locations or positions which effect the results. Refer to Table VI.

b. See discussion in "Normalization of Results."

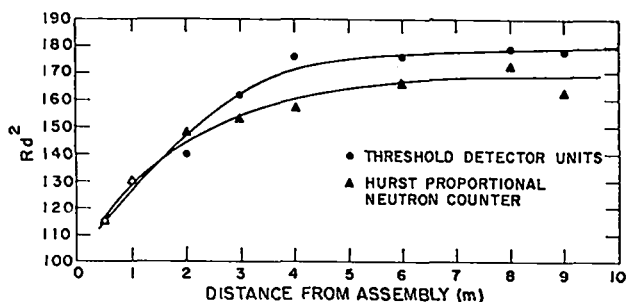

Fig. 14. Plot of kerma and first-collision dose times distance squared vs distance from the Jezebel assembly outside kiva.

to total absorbed dose varies as a function of neutron energy,³² and, for the fairly large variations in neutron spectra used in this study, significantly different factors would be applied. The kerma from fast neutrons is, however, the neutron dose that can be most conveniently measured, and consequently, it was chosen for the normalization factor.

RESULTS

Hurst Proportional Neutron Counter and Threshold Detector Units. The first-collision absorbed dose from fast neutrons determined by the HPC and the kerma determined by the TDU are given in Table VII. The results from the two techniques agree well. The HPC results average 5% lower than the TDU results for distances of >3 meters from Jezebel and 10% lower for all the Flattop data. The HPC results average 14% higher than the TDU results for the Hydro data and 31% higher for the Parka data. The differences occur at least partially because the TDU system is not so sensitive to the intermediate-energy neutrons as is the HPC. Therefore, HPC results for spectra containing significant intermediate-energy neutrons, such as those of Hydro and Parka, are higher than those obtained with the TDU system.

A plot of the kerma and first-collision

dose times the distance squared for the Jezebel assembly located outside the kiva is given in Fig. 14. For this type of plot, an inverse-square relationship gives a straight line with zero slope. Our curve indicates that out to about 4 meters there is an increase in the kerma and first-collision absorbed dose over that expected using the inverse-square rule. Beyond 4 meters an equilibrium with scattered neutrons is reached, and the curve begins to flatten out, indicating an approach to the inverse-square relationship. Results obtained with the multisphere and 10-in.-sphere neutron detector differ from these and are discussed later.

Table VIII shows the data, obtained with the TDU system, used to determine the kerma from fast neutrons. The count rate of the plutonium foil is given in cpm normalized to hectoerg/g of fast neutrons (see Table VII), and the neptunium, uranium, and sulfur results are relative to the plutonium count. Table IX shows the neutron fluences determined by the TDU system for each energy interval.

Table X shows the percent of the total kerma in each energy interval as determined by the TDU system. The changes in the percentages reflect the changes in the spectra of the various assemblies as the distance from the assembly is increased. The percentage of the total kerma in the >2.9-MeV energy interval (sulfur) indicates that the total kerma is not related to that determined by sulfur activation, and it is shown to vary from 8 to 48%. These percentages are important in the ³²P analysis of hair following a criticality accident.^{33,34} To relate hair activation to total kerma, the proper percentage would have to be applied.

Nuclear Track Film. Blackening of the

TABLE VIII.

DATA OBTAINED WITH THRESHOLD DETECTOR UNITS

Critical Assembly	Distance from Assembly (meters)	Count Rate of Pu per Hectoergs/g ^b (cpm)	Count Rate Relative to Plutonium (Pu count rate normalized to 1.0)			
			<u>Np</u>	<u>U</u>	<u>S</u>	
Jezebel (outside kiva)	0.5	137	0.77	0.17	0.070	
	1.0	141	0.78	0.17	0.070	
	2.0	149	0.68	0.16	0.062	
	3.0	162	0.58	0.13	0.052	
	4.0	165	0.59	0.13	0.046	
	6.0	147	0.76	0.16	0.052	
	8.0	173	0.53	0.12	0.040	
	9.0	184	0.46	0.12	0.030	
	2.0 ^a	178	0.50	0.11	0.036	
	7.7 ^a	165	0.64	0.12	0.040	
	(inside kiva)	3.0	162	0.66	0.13	0.048
		3.0 ^a	156	0.68	0.13	0.048
		6.0	169	0.56	0.12	0.038
9.0		189	0.47	0.10	0.028	
(outside kiva, 90 cm from wall)	2.0 ^a	158	0.62	0.13	0.050	
	3.0	169	0.58	0.11	0.054	
	9.0	159	0.59	0.12	0.058	
Hydro	6.0	190	0.34	0.055	0.032	
	6.0 ^a	194	0.37	0.053	0.034	
	5.9	189	0.39	0.060	0.036	
	8.7	191	0.42	0.056	0.034	
	12.3	179	0.54	0.054	0.030	
	16.2	197	0.36	0.057	0.028	
	19.8	192	0.37	0.062	0.038	
	19.8 ^a	203	0.34	0.050	0.024	
Flattop	1.1	245	0.23	0.020	0.0070	
	3.0	240	0.25	0.023	0.0094	
	6.1	280	0.19	0.025	0.0062	
	~13 ^a	571	1.09	0.34	0.054	
Parka	3.0	183	0.35	0.055	0.0258	
	3.0 ^a	171	0.50	0.025	0.0231	
Godiva IV (burst) (D.C.)	3.0	175	0.53	0.091	0.028	
	3.0	168	0.58	0.098	0.030	

a. These data were obtained at locations or positions which affect the results.

b. See discussion in "Normalization of Results."

nuclear track film by gamma rays and thermal neutrons made it impossible to determine the fast neutron dose except for some of the lower doses. The results are shown on Table XI. The nuclear track film badge results are given in Rem. For the badges on the front of the plastic men they were

found to be about 10 times greater than the kerma measured in air, and for the badges on the backs of the men, about twice as great.

Thermal Neutron Dose From Film Badge, Gold Foils, and Lithium-Iodide Crystal. The dose from thermal neutrons was determined

TABLE IX.

NEUTRON FLUENCE DETERMINED BY THRESHOLD DETECTOR UNIT SYSTEM

Critical Assembly	Distance from Assembly (meters)	Neutron Fluence 10^{10} n/cm ²				Thermal	
		>2.9 MeV	1.5-2.9 MeV	0.75-1.5 MeV	0.4-750 keV		
Jezebel (outside kiva)	0.5	4.93	3.09	5.47	0.39	0.028	
	1.0	1.43	0.81	1.69	0.09	0.030	
	2.0	0.321	0.208	0.330	0.151	0.021	
	3.0	0.169	0.116	0.184	0.170	0.020	
	4.0	0.092	0.080	0.122	0.105	0.014	
	6.0	0.043	0.0409	0.0671	0.007	0.0073	
	8.0	0.022	0.0196	0.0284	0.036	0.0055	
	9.0	0.014	0.0210	0.0160	0.0377	0.0046	
	2.0 ^a	0.045	0.0441	0.0669	0.095	0.046	
	7.7 ^a	0.024	0.0224	0.0492	0.024	0.013	
	(inside kiva)	3.0	0.167	0.128	0.260	0.119	0.11
		3.0 ^a	0.173	0.128	0.308	0.109	0.11
		6.0	0.045	0.0492	0.0718	0.068	0.066
9.0		0.018	0.020	0.033	0.049	0.052	
(outside kiva, 90 cm from wall)	2.0 ^a	0.404	0.286	0.52	0.35	0.092	
	3.0	0.202	0.070	0.264	0.205	0.061	
	9.0	0.0267	0.0083	0.0416	0.0143	0.012	
Hydro	6.0	0.031	0.0064	0.0866	0.102	0.053	
	6.0 ^a	0.031	0.0017	0.0723	0.101	0.048	
	5.9	0.035	0.0051	0.0829	0.101	0.052	
	8.7	0.015	0.0026	0.0434	0.043	0.027	
	12.3	0.0077	0.00159	0.0345	0.0138	0.014	
	16.2	0.0042	0.0017	0.0723	0.1010	0.0097	
	19.8	0.0038	0.0051	0.0079	0.0111	0.0074	
	19.8 ^a	0.0034	0.00136	0.0103	0.0165	0.014	
Flattop	1.1	0.061	0.056	0.585	1.30	0.058	
	3.0	0.012	0.0081	0.0889	0.181	0.060	
	6.1	0.0030	0.00518	0.0148	0.088	0.045	
	~13 ^a	0.0026	0.0085	0.0069	-	-	
Parka	3.0	0.031	0.0193	0.0537	0.280	0.69	
	3.0 ^a	0.017	-	0.0788	0.144	0.43	
Godiva IV (burst) (D.C.)	3.0	0.71	0.79	1.97	1.41	0.70	
	3.0	0.73	0.84	2.18	1.01	0.72	

a. These data were obtained at locations or positions which affect the results. Refer to Table VI.

by using film badges, gold foils, and the lithium-iodide crystal detector of the sphere-neutron detector. The thermal neutron dose in Rem normalized to 1 hectoerg/g of fast neutrons is given in Table XII. It is generally quite small compared to the

fast neutron dose.

The lithium-iodide crystal and gold foil results agree within a few percent except for Parka. Except for that from the Parka assembly, the thermal-neutron dose determined by film badges was higher than the

TABLE X.
PERCENT OF TOTAL KERMA IN EACH ENERGY INTERVAL
(DETERMINED BY TDU SYSTEM)

Critical Assembly	Distance from Assembly (meters)	Percentage of Total Kerma			
		0_S	$^0_U - ^0_S$	$^{238}_{92}\text{U} - ^0_U$	$^{239}_{94}\text{Pu} - ^{238}_{92}\text{U}$
		>2.9 MeV	1.5-2.9 MeV	0.75-1.5 MeV	0.4-750 KeV
Jezebel (outside kiva)	0.5	48	22	29	1.2
	1.0	48	21	30	1
	2.0	46	22	25	7
	3.0	42	21	23	14
	4.0	37	24	25	14
	6.0	39	29	31	2
	8.0	35	23	23	19
	9.0	28	31	17	24
	2.0 ^a	31	23	23	22
	7.7 ^a	34	23	34	10
(inside kiva)	3.0	39	22	31	9
	3.0 ^a	38	20	34	8
	6.0	32	25	27	16
	9.0	28	22	26	24
(outside kiva, 90 cm from wall)	2.0 ^a	41	21	27	11
	3.0	44	11	30	15
	9.0	45	10	36	8
Hydro	6.0	30	4.5	38	28
	6.0 ^a	33	1.2	35	31
	5.9	34	3.4	36	27
	8.7	30	3.6	41	25
	12.3	27	3.8	56	14
	16.2	28	7.2	33	32
	19.8	35	4.1	33	29
	19.8 ^a	24	6.3	35	35
Flattop	1.1	8.3	5.5	43	43
	3.0	11	5.3	43	41
	6.1	8	10	22	60
	~13 ^a	-	-	-	-
Parka	3.0	23	10	22	45
	3.0 ^a	19	0	48	33
Godiva IV (burst) (D.C.)	3.0	24	20	37	18
	3.0	25	22	41	13

a. These data were obtained at locations or positions which affect the results. Refer to Table VI.

TABLE XI.

NUCLEAR TRACK FILM RESULTS

Critical Assembly	Distance from Assembly (meters)	Threshold Detector Units (hectoergs/g) ^b	Nuclear Track Film Badge		
			Front of Plastic Man (Rem)	Back of Plastic Man (Rem)	
Jezebel (outside kiva)	0.5	460	-	-	
	1.0	130	-	-	
	2.0	35	-	-	
	3.0	18	-	-	
	4.0	11	-	23.8	
	6.0	4.9	-	-	
	8.0	2.8	24.4	6.4	
	9.0	2.2	30.4	2.9	
	2.0 ^a	6.4	-	18.9	
	7.7 ^a	3.3	42.2	17.6	
	3.0 (fat man)	18	-	24.9	
	(inside kiva)	3.0	19	-	-
		3.0 ^a	21	-	-
6.0		6.3	-	-	
9.0		2.9	-	-	
(outside kiva, 90 cm from wall)	2.0 ^a	45	-	-	
	3.0	20	-	29	
	9.0	2.6	22.6	0.7	
Hydro	6.0	4.8	-	-	
	6.0 ^a	4.3	-	-	
	5.9	4.8	-	-	
	8.7	2.2	-	-	
	12.3	1.3	-	-	
	16.2	0.69	-	-	
	19.8	0.49	-	-	
	19.8 ^a	0.63	-	-	
Flattop	1.1	33	-	-	
	3.0	4.9	-	2.0	
	6.1	1.6	-	-	
	~13 ^a	(0.077)	0.13	0.02	
Parka	3.0	6.1	-	-	
	3.0 ^a	4.2	-	-	
Godiva IV (burst) (D.C.)	3.0	127	-	-	
	3.0	129	-	-	

a. These data were obtained at locations or positions which affect the results. Refer to Table VI.

b. See discussion in "Normalization of Results."

gold and lithium-iodide crystal results by two to four times, with the Jezebel data obtained outside the kiva giving the largest deviation. The film badge on the back of the plastic man indicated a dose that was ~50% of that shown by the badge on the front of the man. The data from film badges used with the Parka assembly, although incomplete, appear lower than expected, based on the results from the other assemblies.

The cadmium ratios obtained with the gold foils and lithium-iodide crystals are given in Table XII. The lithium-iodide crystal gave cadmium ratios which were, in most cases, higher than the gold foil ratios.

The data obtained with the gold foils and the lithium-iodide crystals from the Jezebel assembly located outside the kiva

are plotted in Fig. 15 as a function of distance from the assembly. The thermal-neutron fluence is highest about 1 meter from the assembly. This compares to a thermal-neutron fluence peaking at ~3 meters for the Health Physics Research reactor at Oak Ridge. The Flattop thermal-neutron fluence (Table XII) appears to peak at a greater distance than the Jezebel fluence and could be peaking at about 3 meters.

Multisphere Technique and 10-In.-Sphere Neutron Detector. The results obtained with the multisphere technique and the 10-in.-sphere neutron detector are shown in Tables XIII and XIV. The count rate of the 8-in. sphere normalized to 1 hectoerg/g of fast neutrons (see Table VII), and the count rates of the 2- and 3-in. spheres relative to that of the 8-in. sphere are given in

TABLE XII.

THERMAL NEUTRON DOSE NORMALIZED TO 1 HECTOERG/G OF FAST NEUTRONS

Critical Assembly	Distance from Assembly (meters)	LiI Crystal (Rem) ^b	Gold Foils (Rem) ^b	Film Badge		Cadmium Ratio		
				Front of Plastic Man (Rem)	Back of Plastic Man (Rem)	LiI Crystal	Gold Foils	
Jezebel (outside kiva)	0.5	0.00053	0.00064	-	-	1.4	1.6	
	1.0	0.0020	0.0024	-	-	1.8	2.2	
	2.0	0.0065	0.0068	-	0.022	2.5	2.5	
	3.0	0.011	0.012	0.041	0.018	3.5	2.6	
	4.0	0.012	0.013	0.049	0.026	2.9	2.3	
	6.0	0.014	0.016	0.049	0.024	3.0	2.4	
	8.0	0.015	0.021	0.061	0.028	2.7	2.6	
	9.0	0.020	0.022	0.064	0.032	3.8	2.8	
	2.0 ^a	0.13	0.075	0.21	0.038	4.4	3.0	
	7.7 ^a	0.045	0.042	0.064	0.076	3.3	2.6	
	3.0 (fat man)	0.011	0.012	0.046	0.018			
	3.0 (sideways)	0.011	0.012	0.019	0.032			
	(inside kiva)	3.0	0.048	0.058	0.092	0.047	3.8	3.0
		3.0 ^a	0.049	0.057	0.068	0.068	4.6	2.9
		6.0	0.094	0.11	0.16	0.081	5.0	3.1
9.0		0.15	0.19	0.22	0.18	4.2	3.2	
(outside kiva, 90 cm from wall)	2.0 ^a	0.022	0.021	0.058	0.028	3.2	2.6	
	3.0	0.027	0.032	0.096	0.027	3.0	2.6	
	9.0	0.048	0.049	0.10	0.046	4.0	2.7	
Hydro	6.0	0.096	0.11			3.5	3.2	
	6.0 ^a	0.13	0.12			4.9	2.9	
	5.9	0.11	0.11			4.5	3.2	
	8.7	0.11	0.13			3.3	3.1	
	12.3	0.10	0.11			3.3	2.8	
	16.2	0.14	0.15			4.4	3.1	
	19.8	0.13	0.16			3.6	3.0	
	19.8 ^a	0.18	0.22			3.7	3.3	
	5.9 (fat man)	0.11	0.11			4.5	3.2	
6.0 (sideways)	0.096	0.11			3.5	3.2		
Flattop	1.1	0.02	0.018			2.3	2.1	
	3.0	0.12	0.13	0.21	0.11	3.3	2.6	
	6.1 ^a	0.29	0.29			4.5	2.9	
	~13 ^a	0.86	-	1.7	0.78	5.1	-	
Parka	3.0	0.75	1.03	-	-	4.8	3.0	
	3.0 ^a	0.79	1.08	-	0.48	3.9	2.9	
	3.0 (fat man)	0.75	1.03	-	0.30			
	3.0 (sideways)	0.75	1.03	0.34	0.38			
Godiva IV (burst) (D.C.)	3.0		0.058	-	-	-	3.1	
	3.0		0.058	-	-	-	3.4	

a. These data were obtained at locations or positions which affect the results. Refer to Table VI.

b. To convert to first-collision absorbed dose, multiply by 2.682×10^{-2} (2.8×10^{-11} rad/n/cm²). To convert to maximum-absorbed dose, multiply by 3.065×10^{-1} (3.2×10^{-10} rad/n/cm²).

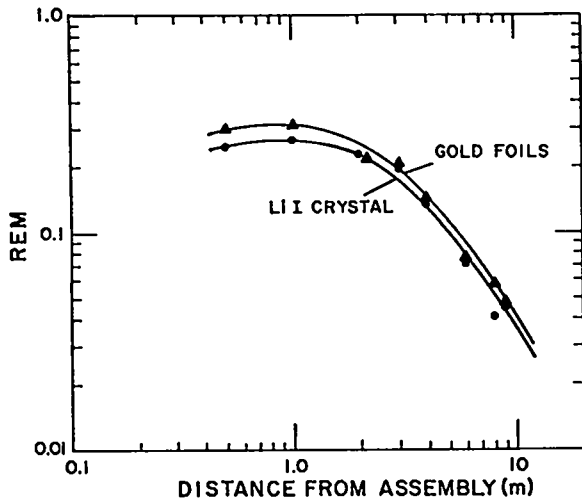

Fig. 15. Thermal-neutron dose equivalent from the Jezebel assembly outside kiva.

Table XIII. The different assemblies showed a variation of a factor of five for the normalized 8-in.-sphere count rate, and the 2-in.-sphere count varied from ~5% of, to slightly greater than, the 8-in.-sphere count rate. The large variations in the 2- and 3-in.-sphere count rates reflect the different neutron-energy spectra.

The relative count rates of the 2-, 3-, and 8-in. spheres were used to determine the average fast neutron energy and percent of fast neutrons by applying the "multisphere technique" described in Reference 21. The results are given in the last two columns of Table XIII and indicate average energies of from 1.0 to 0.10 MeV and from 97 to 18% fast neutrons. A gradual decrease in the average fast neutron energy and the percentage of fast neutrons was found with increasing distance from the various assemblies.

Table XIV shows the dose equivalents obtained with the multisphere technique and 10-in. sphere normalized to 1 hectoerg/g of fast neutrons. The total dose equivalent obtained by the multisphere technique average ~11 Rem for Jezebel and Flattop, ~16 Rem

for Hydro, and 13.5 Rem for the Parka assembly. The dose equivalents obtained with the 10-in. sphere average 13 Rem for Jezebel, 16 Rem for Flattop, 20 Rem for Hydro, and 24.5 Rem for Parka. These variations reflect the differences in the neutron spectra and the energy response of the dosimetry technique.

A plot of the dose equivalent times distance squared versus distance from the assembly is shown in Fig. 16. Unlike the plot of the kerma and first-collision absorbed dose in Fig. 14, the dose equivalent curves continue to rise out to 9 meters indicating a continuing increase over the dose calculated using the inverse-square relationship.

Geiger Counter Readings at Abdomen and of Indium Foils. The Geiger counter readings at the abdomen of the plastic man and the readings of the indium foils were normalized to 1 hectoerg/g of fast neutrons and are shown in Table XV. The readings at the abdomen vary by a factor of ~10 for the different assemblies. These results correlate by $\pm 35\%$ with the blood-sodium activation to be given later. Exact correlation of blood sodium activity and Geiger counter readings was not expected because the inherent fluctuations in portable Geiger counters make accurate reading difficult and because the plastic man with the skeleton retained a significant reading after the solution was removed. The plastic man without the skeleton had a reading of essentially background after the solution was removed. These data give lower Geiger counter readings than would be obtained from a real person because, in addition to the ^{24}Na activity, ^{38}Cl activity is induced in the person. A correction factor is given later for the ^{38}Cl activity (see Fig. 17).

TABLE XIII.

SPHERE DATA AND MULTISPHERE TECHNIQUE RESULTS

Critical Assembly	Distance from Assembly (meters)	8-in.-Sphere Count Rate ^b (cpm)	Count Rate Relative To 8-in. Sphere		Average Fast Neutron Energy (MeV)	Percent Fast Neutrons	
			2-in. Sphere	3-in. Sphere			
Jezebel (outside kiva)	0.5	10.5 x 10 ⁶	0.042	0.24	1.0	97	
	1.0	10.0 x 10 ⁶	0.054	0.25	1.0	95	
	2.0	10.4 x 10 ⁶	0.068	0.28	0.9	93	
	3.0	9.45 x 10 ⁶	0.077	0.31	0.85	91	
	4.0	8.46 x 10 ⁶	0.12	0.37	0.9	81	
	6.0	9.98 x 10 ⁶	0.12	0.36	0.9	80	
	8.0	10.4 x 10 ⁶	0.11	0.36	0.8	84	
	9.0	10.9 x 10 ⁶	0.11	0.37	0.75	86	
	2.0 ^a	21.3 x 10 ⁶	0.22	0.55	0.7	66	
	7.7 ^a	12.5 x 10 ⁶	0.18	0.50	0.6	74	
	(inside kiva)	3.0	9.59 x 10 ⁶	0.19	0.50	0.75	69
		3.0 ^a	10.0 x 10 ⁶	0.18	0.47	0.9	68
		6.0	10.8 x 10 ⁶	0.25	0.59	0.75	61
9.0		11.8 x 10 ⁶	0.37	0.83	0.5	51	
(outside kiva, 90 cm from wall)	2.0 ^a	9.53 x 10 ⁶	0.13	0.39	-	-	
	3.0	8.85 x 10 ⁶	0.18	0.50	0.9	79	
	9.0	12.2 x 10 ⁶	0.17	0.51	0.75	86	
Hydro	6.0	17.7 x 10 ⁶	0.24	0.66	0.4	71	
	6.0 ^a	21.5 x 10 ⁶	0.23	0.67	0.37	77	
	5.9	21.8 x 10 ⁶	0.20	0.59	0.4	79	
	8.7	20.8 x 10 ⁶	0.24	0.65	0.4	71	
	12.3	18.4 x 10 ⁶	0.25	0.69	0.4	69	
	16.2	20.0 x 10 ⁶	0.28	0.75	0.35	72	
	19.8	18.1 x 10 ⁶	0.30	0.76	0.38	66	
	19.8 ^a	19.4 x 10 ⁶	0.36	0.85	0.38	58	
Flattop	1.1	17.0 x 10 ⁶	0.18	0.65	0.25	89	
	3.0	16.6 x 10 ⁶	0.36	0.95	0.20	65	
	6.1	20.6 x 10 ⁶	0.51	1.17	0.15	56	
	~13.0 ^a	17.5 x 10 ⁶	1.03	1.87	0.10	27	
Parka	3.0	49.4 x 10 ⁶	0.78	1.46	0.3	27	
	3.0 ^a	51.6 x 10 ⁶	0.90	1.59	0.4	18	
Godiva IV (burst) (D.C.)	3.0	-	-	-	-	-	
	3.0	-	-	-	-	-	

a. These data were obtained at locations or positions which affect the results. Refer to Table VI.

b. The sphere count rate was divided by the kerma, using the TDU system to give the cpm/hectoerg/g values.

The indium foil Geiger counter readings varied from 0.13 to 33 mR/h when normalized to 1 hectoerg/g of fast neutrons. The lowest reading was obtained with the

plastic man 50 cm from Jezebel (see Fig. 1). This low reading was partly caused by the increased distance from the foils on the upper chest to the center of the assembly

TABLE XIV
MULTISPHERE TECHNIQUE AND 10-IN.-SPHERE NEUTRON DETECTOR RESULTS

Critical Assembly	Distance from Assembly (meters)	Multisphere Technique			10-in. Sphere Neutron Detector (Rem)	
		Fast Neutrons (Rem)	Intermediate Energy Neutrons (Rem)	Total Fast, Intermediate, and Thermal (rem)		
Jezebel (outside kiva)	0.5	14	0.16	14	-	
	1.0	13	0.26	13	13	
	2.0	13	0.37	13	13	
	3.0	10	0.40	11	12	
	4.0	8.9	0.80	10	11	
	6.0	10	1.0	11	12	
	8.0	11	0.78	12	12	
	9.0	12	0.73	12	13	
	2.0 ^a	17	3.3	21	25	
	7.7 ^a	11	1.4	12	15	
	(inside kiva)	3.0	8.2	1.4	10	12
		3.0 ^a	8.8	1.6	11	12
		6.0	8.1	2.0	10	12
		9.0	6.7	2.3	9	13
	(outside kiva, 90 cm from wall)	2.0 ^a	9.8	1.0	11	12
3.0		9.4	0.6	10	11	
9.0		11	1.2	12	14	
Hydro	6.0	13	2.0	15	18	
	6.0 ^a	17	1.8	19	22	
	5.9	18	1.7	20	22	
	8.7	15	2.3	18	21	
	12.3	13	2.2	16	18	
	16.2	15	2.0	17	20	
	19.8	12	2.2	15	18	
	19.8 ^a	12	3.0	15	19	
Flattop	1.1	14	0.62	15	15	
	3.0	9.4	1.8	11	15	
	6.1	9.1	2.5	12	18	
	13 ^a	3.2	3.2	7	17	
Parka	3.0	6.4	6.1	13	24	
	3.0 ^a	4.9	8.1	14	25	
Godiva IV (burst) (D.C.)	3.0					
	3.0					

a. These data were obtained at locations or positions which affect the results. Refer to Table VI.

b. Thermal neutron dose equivalent given in Table XII.

core, between 60 to 65 cm. For all irradiations the foils on the backs of the plastic men averaged about half as high a reading as those on the front. The results with Hydro indicate that a factor of two variation can be expected with side irradiations depending on the side of the chest on which the foils are located.

Sodium Activation. The ²⁴Na activation of the solution corrected for concentration and skin effect is given in Table XVI. Variations of a factor of 10 were found when the sodium activation was normalized

to 1 hectoerg/g of fast neutrons. The side-ways irradiation results were 64, 72, and 74% of those from the face-on irradiations. The "fat man" irradiations (with solution-filled plastic bag added to the torso) were 95, 99, and 99% of those obtained with the normal plastic man.

Thermoluminescent Dosimeters and Film Badges. The gamma-to-neutron ratios obtained with the TLD's and film badges are given in Table XVII. The smallest gamma-to-neutron ratio obtained with the TLD's in air was 0.049 at 1.1 meters from the Flattop as-

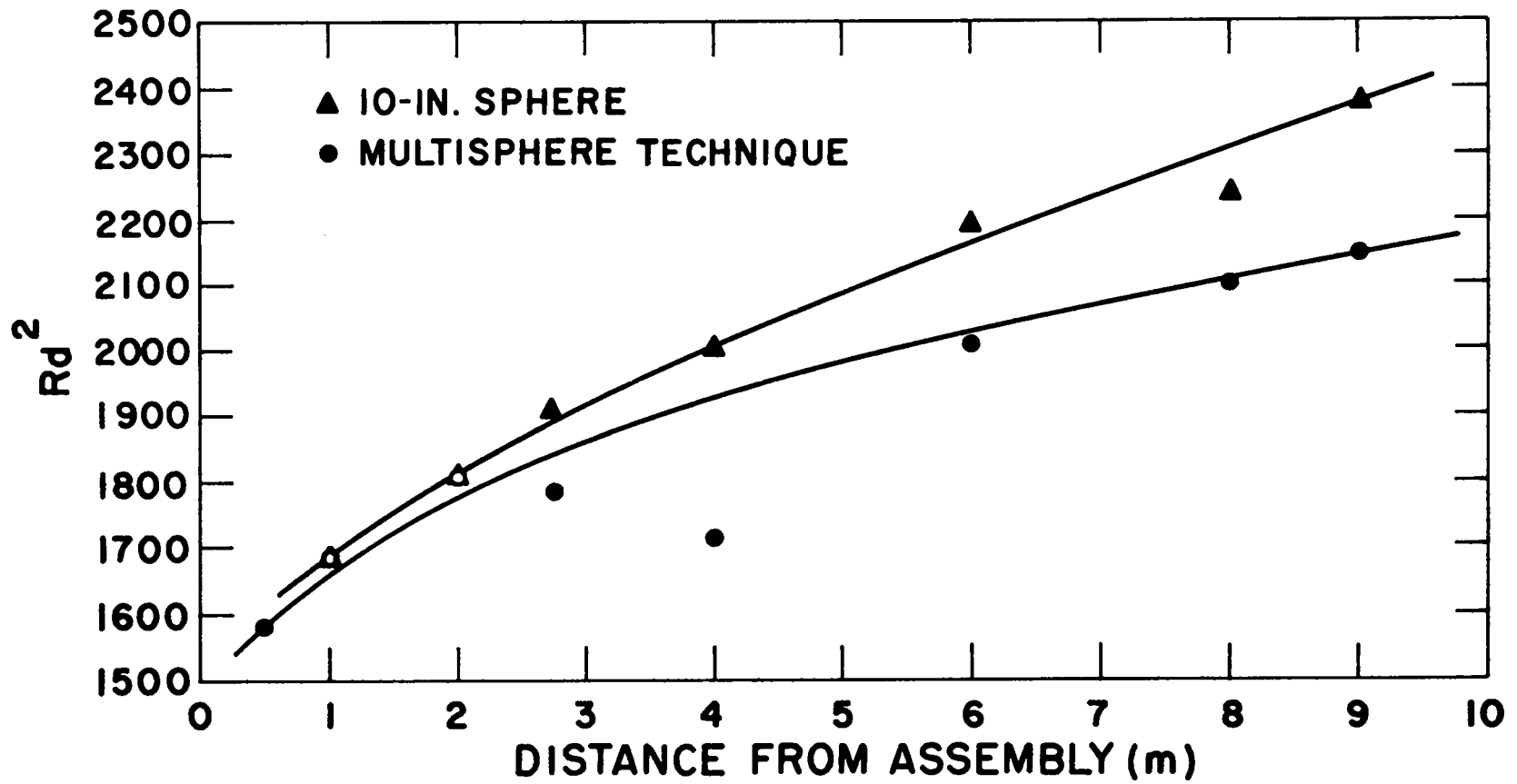

Fig. 16. Plot of dose equivalent times distance squared vs distance from the Jezebel assembly outside kiva.

TABLE XV.

GEIGER COUNTER READINGS AT ABDOMEN AND OF INDIUM FOILS

Critical Assembly	Distance from Assembly (meters)	Geiger Counter Reading at Abdomen (mR/hr)	Indium Foils		
			Front of Plastic Man ^b (mR/hr)	Back of Plastic Man ^b (mR/hr)	
Jezebel (outside kiva)	0.5	0.0049	0.13	0.13	
	1.0	0.0059	0.55	0.25	
	2.0	0.0050	1.1	0.45	
	3.0	0.0057	1.0	0.43	
	4.0	0.0075	1.1	0.54	
	6.0	0.0073	1.3	-	
	8.0	0.0051	1.9	0.52	
	9.0	0.0047	1.8	0.70	
	2.0 ^a	0.010	2.5	0.51	
	7.7 ^a	0.0096	1.7	1.5	
	3.0 (fat man)	0.0068	1.0	0.47	
	3.0 (sideways)	0.0032	0.52	0.49	
	(inside kiva)	3.0	0.0067	1.7	-
		3.0 ^a	0.0061	2.1	-
		6.0	0.0096	3.5	1.9
9.0		0.0074	4.4	3.6	
(outside kiva, 90 cm from wall)	2.0 ^a	0.0064	1.2	0.50	
	3.0	0.0072	2.0	0.56	
	9.0	0.012	3.2	0.69	
Hydro	6.0	0.012	3.6	-	
	6.0 ^a	0.024	4.1	-	
	5.9	0.015	-	-	
	8.7	0.018	6.7	-	
	12.3	0.017	4.0	-	
	16.2	0.015	5.7	-	
	19.8	0.037	8.0	-	
	19.8 ^a	0.024	5.2	-	
	5.9 (fat man)	0.017	5.1	-	
	6.0 (sideways)	0.0079	c	-	
Flattop	1.1	0.012	3.5	-	
	3.0	0.013	4.9	2.6	
	6.1	0.026	13	-	
	13 ^a	-	33	1.1	
Parka	3.0	0.029	13	4.9	
	3.0 ^a	0.037	20	10	
	3.0 (fat man)	0.049	21	6.6	
	3.0 (sideways)	0.019	6.8	5.7	
Godiva IV (burst) (D.C.)	3.0	0.0068	1.2	0.84	
	3.0	0.0081	1.7	0.98	

a. These data were obtained at locations or positions which affect the results. Refer to Table VI.

b. Geiger counter reading taken in contact with foil, and decay corrected to midtime of the assembly operation or burst time.

c. Right breast 3.7, left breast 1.9.

TABLE XVI

SODIUM ACTIVATION OF THE SOLUTION
IN THE PLASTIC MEN^b

Critical Assembly	Distance from Assembly (meters)	$\frac{\mu\text{Ci } ^{24}\text{Na}}{\text{mg } ^{23}\text{Na}}$ ($\times 10^{-6}$)	
Jezebel (outside kiva)	0.5	1.03	
	1.0	1.32	
	2.0	1.41	
	3.0	1.47	
	4.0	1.43	
	6.0	1.59	
	8.0	1.65	
	9.0	1.65	
	2.0 ^a	2.45	
	7.7 ^a	1.81	
	3.0 (fat man)	1.39	
	3.0 (sideways)	0.94	
	(inside kiva)	3.0	2.13
		3.0 ^a	2.01
6.0		2.41	
9.0		3.12	
(outside kiva, 90 cm from wall)	2.0 ^a	1.66	
	3.0	1.91	
	9.0	2.28	
Hydro	6.0	3.71	
	6.0 ^a	4.67	
	5.9	4.27	
	8.7	4.42	
	12.3	4.06	
	16.2	4.85	
	19.8	-	
	19.8 ^a	4.41	
	5.9 (fat man)	4.21	
	6.0 (sideways)	2.65	
Flattop	1.1	3.42	
	3.0	4.29	
	6.1	6.16	
	~13 ^a	10.2	
Parka	3.0	9.88	
	3.0 ^a	10.9	
	3.0 (fat man)	9.83	
	3.0 (sideways)	7.31	
Godiva IV (burst) (D.C.)	3.0	1.90	
	3.0	1.95	

a. These data were obtained at locations or positions which affect the results. Refer to Table VI.

b. Corrected for effect on plastic skin by dividing the observed activity by the following factors:

Jezebel, 1.09; Hydro, 1.07; Flattop, 1.04; Parka, 1.05; and Godiva, 1.09.

sembly, and the largest was 1.7 at 3 meters from Parka.

The TLD's on the front of the plastic men had gamma-to-neutron ratios higher than the in-air ratios by a factor of ~2.2 for Jezebel, ~1.4 for Hydro and Godiva, ~1.2 for Parka, and 1.3 to 8.0 for Flattop. The TLD's on the backs of the plastic men averaged about 60% of the front exposure.

The film badge results were within $\pm 35\%$ of the exposures indicated by the TLD's.

APPLICATION OF RESULTS TO CRITICALITY ACCIDENTS

The results in many cases had large variations because of distance from the assembly, effect of walls and buildings, differences in the neutron spectra, or orientation of the plastic men. The largest variations were caused by the differences in the neutron spectra of the five assemblies. A primary requirement for a dosimetry study of an accidental excursion is to obtain as much information as possible on the critical system and the location of the exposed persons. Much of the information required can be obtained by answering the following questions:

What are the approximate dimensions of the critical system?

In what form (metal, solution, graphite matrix) was the fission material?

Did the system have a reflector; if so, what and how thick was it?

Where was the critical system located with respect to the floor, walls, and other bulky objects?

Where were the exposed persons during the excursion?

What was the orientation of the exposed persons?

What dosimetry aids (film badges, indium foils, dosimetry systems on persons or at locations in the room) are available?

TABLE XVII.

GAMMA-TO-NEUTRON RATIOS OBTAINED WITH THERMOLUMINESCENT
DOSIMETERS AND FILM BADGES

Critical Assembly	Distance from Assembly (meters)	Thermoluminescent Dosimeters			Film Badges		
		In Air	On Plastic Man		On Plastic Man		
			Front	Back	Front	Back	
Jezebel (outside kiva)	0.5	0.10	0.11-0.30 ^b	0.047	-	-	
	1.0	0.097	0.23	0.098	-	-	
	2.0	0.089	0.20	0.11	-	0.11	
	3.0	0.10	0.20	0.11	0.14	0.10	
	4.0	0.09	0.18	0.10	0.18	0.12	
	6.0	0.09	0.21	0.14	0.14	0.14	
	8.0	0.10	0.19	0.12	0.20	0.12	
	9.0	0.10	0.19	0.11	0.20	0.14	
	2.0 ^a	0.30	0.56	0.26	0.44	0.26	
	7.7 ^a	0.11	0.18	0.16	0.21	0.17	
	3.0 (fat man)	0.10	0.22	0.094 ^c	0.18	0.088	
	3.0 (sideways)	0.10	0.13 ^c	0.12 ^c	0.13	0.13	
	(inside kiva)	3.0	0.13	0.33	0.19	0.32	0.23
		3.0 ^a	0.11	0.30	0.17	0.34	0.17
		6.0	0.15	0.33 ^c	0.23 ^c	0.40	0.33
	9.0	0.21	0.40 ^c	0.39 ^c	0.57	0.46	
(outside kiva, 90 cm from wall)	2.0 ^a	0.11	0.15	0.075	0.19	0.088	
	3.0	0.11	0.21	0.10	0.19	0.12	
	9.0	0.13	0.29 ^c	0.14 ^c	0.24	0.14	
Hydro	6.0	0.82	1.0	0.80			
	6.0 ^a	0.89	1.2	0.71			
	5.9	0.88	1.5	0.89			
	8.7	0.77	1.2	0.88			
	12.3	0.74	1.1	0.60			
	16.2	0.74	1.1	0.74			
	19.8	0.76	0.84	0.57			
	19.8 ^a	0.73	0.79	0.60			
	5.9 (fat man)	-	-	-			
6.0 (sideways)	0.82	1.0	1.1				
Flattop	1.1	0.049	0.39	0.22			
	3.0	0.16	0.35	0.22	0.36	0.25	
	6.1 ^a	0.34	0.84	0.48			
	~13 ^a	1.2	1.6	1.2	1.8	1.2	
Parka	3.0	1.7	2.0	1.1	-	-	
	3.0 ^a	1.6	2.1	1.1	-	1.5	
	3.0 (fat man)	1.7	2.1	1.2	-	1.7	
	3.0 (sideways)	1.7	1.6	1.7	2.0	1.9	
Godiva IV (burst) (D.C.)	3.0	0.13	0.19	0.13	-	-	
	3.0	0.14	0.19	0.13	-	-	

a. These data were obtained at locations or positions which affect the results.
Refer to Table VI.

b. Located at abdomen.

c. ⁷Li thermoluminescent dosimeters.

If answers to all or some of the more important of these questions cannot be obtained, the neutron dose the person received can be determined from a combination of the hair and blood sodium activation. This procedure is discussed later.

To permit a reasonably accurate dose estimate, information about the critical system will have to be obtained, or if the system is not accessible, the type of system involved must be estimated. If the system is similar to one of the critical assemblies used in this study (see Fig. 3), or if the leakage neutron spectrum is similar, the results obtained with that assembly can be applied. For example, the Parka assembly's size, configuration, and leakage-neutron spectrum compare well with the reactor involved in the Yugoslav accident⁶ at the Boris Kidric Institute. The Godiva assembly's leakage-neutron spectrum is similar to that obtained with the threshold detector following the Hanford (Recuplex) excursion, except for the thermal- and lower-energy regions.^{7,8} (The threshold detector evaluated after the Recuplex accident was shielded from the critical system by steel. Consequently, the persons who were not shielded were exposed to a slightly different spectrum.) The leakage-neutron spectrum from the mock-up of the Oak Ridge Y-12 excursion⁵ is not similar to that of any of the assemblies we studied. The Y-12 mock-up had a higher neutron fluence in the 1.5- to 2.9-MeV and thermal-energy regions. However, the enhanced thermal- and intermediate-energy neutrons caused increases in the blood-sodium activation, which permit the Hydro assembly results to be applied.¹⁵ Unfortunately, there are many critical system geometries, and each incident will have to be evaluated individually.

Early Screening of Potentially Exposed

Persons. Early screening of persons who were in the vicinity during the excursion can be accomplished by using indium foils and Geiger counter readings at the abdominal region. Film badges and thermoluminescent dosimeters are not considered as screening devices since the results would require at least an hour to obtain. Pocket gamma-ray dosimeters were not used in this study, but, although they are sensitive primarily to gamma-rays and have a limited dose range, they could be of value in screening.

Geiger Counter Readings at Abdomen.

The Geiger counter reading at the abdomen (Hanford Quick-Sort^{7,8,35}) is probably the most reliable indication that a person has been exposed to neutrons, since indium foils may be forgotten, lost, or not worn. The reading at the abdomen is, however, relatively insensitive. From Fig. 17 it can be seen that for the Jezebel assembly a dose of ~ 15 rad results in a reading of ~ 0.1 mR/h, which is about the minimum detectable radiation level with a Geiger counter. Contamination of the person or his clothing would cause a false reading. If contamination is present, identification of ^{24}Na is required and can be made by using a whole-body counter or simply by placing the person's hand near a NaI crystal used with a pulse-height analyzer. This procedure assumes that the contamination is not ^{24}Na .

The curves given in Fig. 17 show large variations in the Geiger counter readings obtained when exposed to 1 rad of fast neutrons from the various assemblies. The Jezebel curves increase in reading when the assembly is moved near a wall or inside the kiva. This increase must be considered in an accident situation. The curves in Fig. 17 were obtained with plastic men filled with

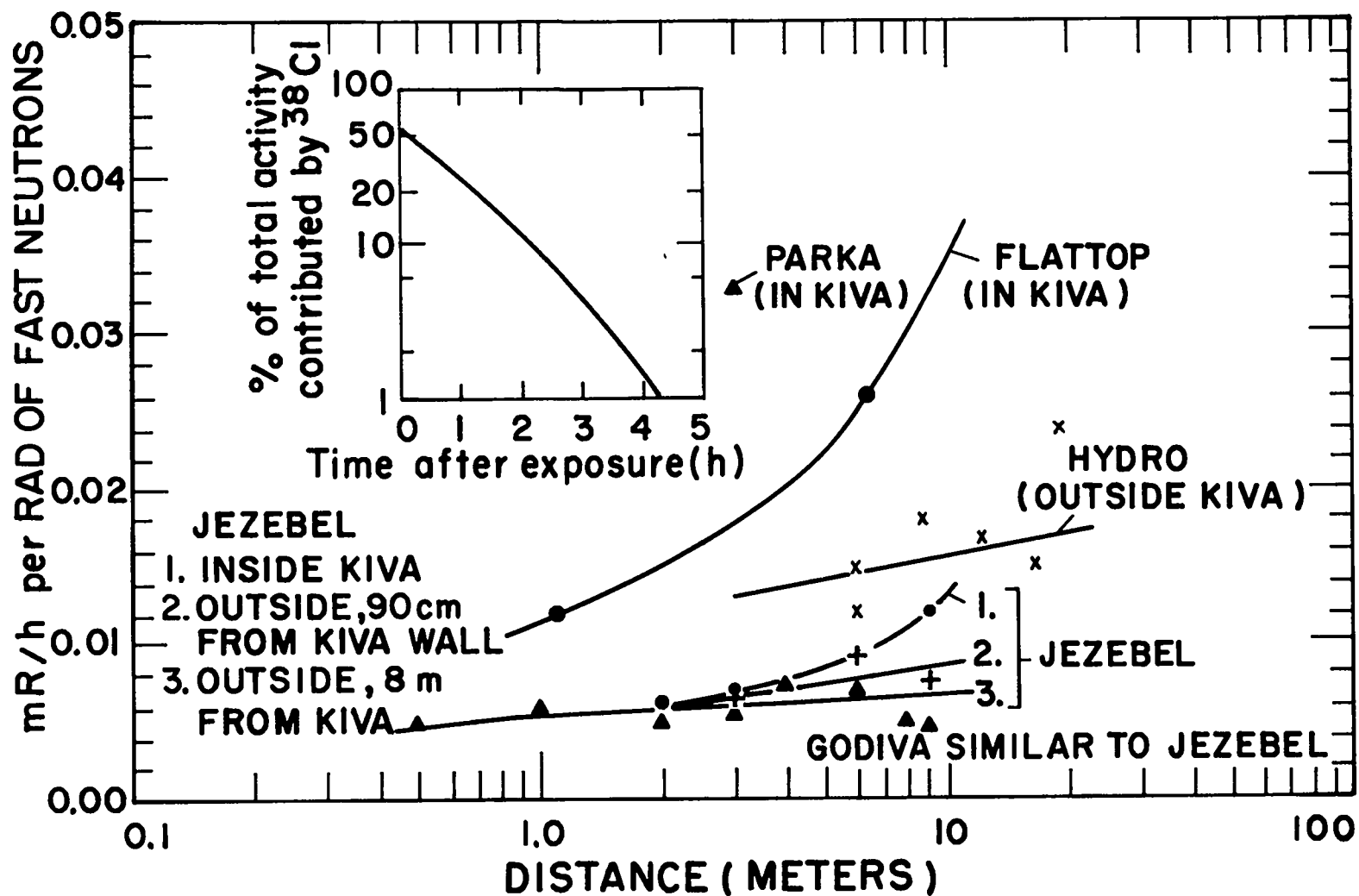

Fig. 17. Geiger counter reading at the abdomen from the ^{24}Na activation in the body of a 62-kg person. (Insert shows correction factor for ^{38}Cl activation in the body which must be applied to the reading before using these curves.)

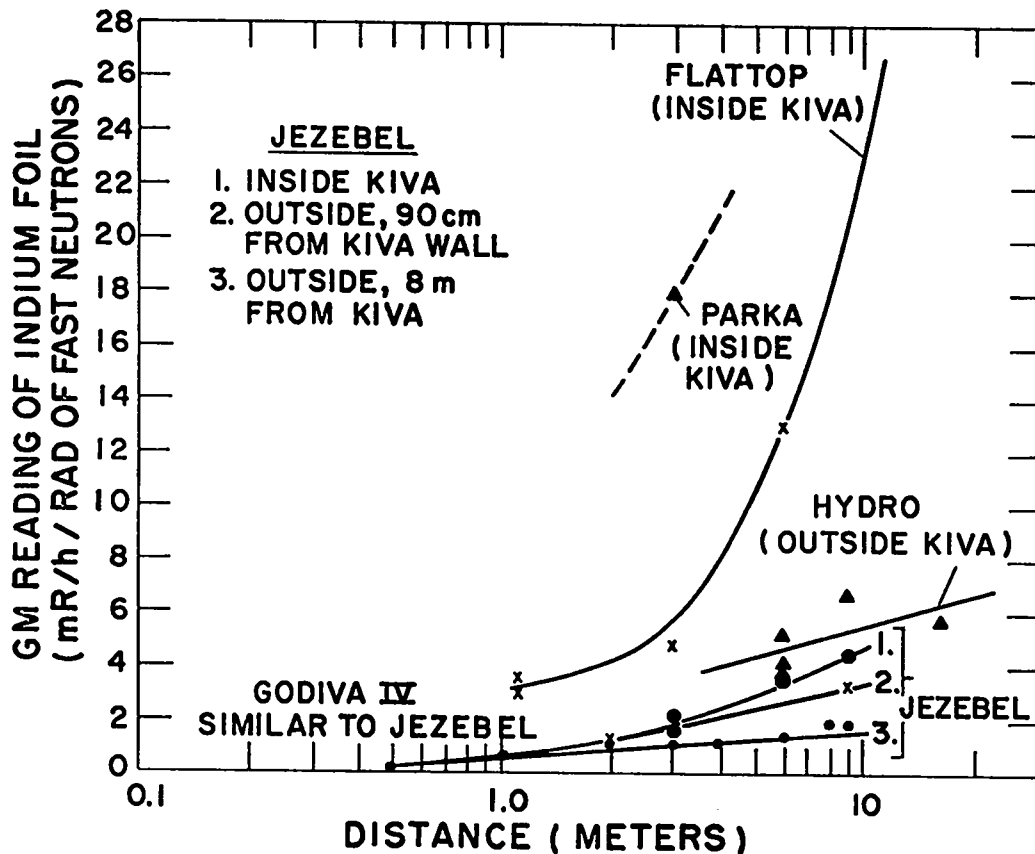

Fig. 18. Geiger counter reading in contact with indium foil, decay corrected to mid time of assembly operation. (1-g foils, 1 1/2 x 4 cm. The 1.3-cm-radius foils have 22% of the reading given here.)

sodium nitrate solution and do not include the ^{38}Cl activity which would be present in a real person. A correction for the ^{38}Cl activity must be made by using the insert given in Fig. 17. (This insert is based on calculated data but agrees well with information given in Reference 36.) A small correction that must also be made for the person's weight will be discussed.

The Geiger counter readings in Fig. 17 were obtained with the plastic men in a standing position. The reading may be increased by having the person seated and leaning forward to surround the probe held at the abdomen. The curves in Fig. 17 would not apply to results obtained in this manner. The conversion for this geometry is not known but is probably about a factor of two.

The estimate of an individual's neutron dose using Geiger counter readings at the abdomen would probably not be better than $\pm 30\%$ if the spectrum were similar to that from one of the critical assemblies we studied. The error may be larger if the spectra are not similar and extrapolations between the curves shown in Fig. 17 are required. The curves in Fig. 17 are for an individual facing the assembly. The other positions studied are discussed in "Exposures Occurring at Unusual Locations or Positions."

Geiger Counter Readings of Indium Foil.

The Geiger counter readings of indium foils normalized to a 1-rad dose of fast neutrons from the various assemblies had extremely large differences (see Fig. 18). This makes the indium foils useful primarily as a

screening agent. The readings of the indium foils exposed to 1 hectoerg/g of fast neutrons varied by as much as a factor of 250 for the different assemblies and by a factor of up to 25 for a given assembly (see Table XV). However, if the critical system is similar to one of the assemblies we studied, and the distance from the person to the system is known, the dose could be obtained to within $\pm 50\%$ by using Fig. 18.

Activation of the indium foil is a positive indication that the person has been exposed to neutrons. Contamination of the foil presents no problem if the foil can be removed from its plastic holder or if a gamma-ray spectrometer is used to check for ^{116}In activation.

The curves given in Fig. 18 are for an individual facing the assembly. If the person is facing away from the assembly, the Geiger counter reading of the indium foil is $\sim 1/2$ the value given in Fig. 18. Readings from the other locations studied are discussed in "Exposures Occurring at Unusual Locations or Positions."

Gamma-Ray Exposures. The first evaluation of the gamma-ray exposure that normally becomes available after an incident is that determined by thermoluminescent dosimeters and film badges, and these are the only gamma-ray exposure results normally obtained. The TLD's and film badges worn by a person will indicate higher exposures than the same dosimeters exposed in air. The Flattop assembly irradiation at 110 cm (see Table XVII) indicates that when the neutron-to-gamma ratio is large, the dosimeter or film badge on a person may indicate an exposure up to eight times higher than the reading made in air. The conversion factor from "in-air" to "on-person" can be obtained from the data given in Table XVII. The re-

sults from dosimeters and film badges placed on the backs of the plastic men are given in Table XVII. Exposures from the other locations studied are discussed in "Exposures Occurring at Unusual Locations and Positions."

The film badge results were obtained with the low-range DuPont 555 film. The high-range, Eastman fine-grain positive film included in the nuclear track film packet was not used.

Many film badges also contain glass rods or thermoluminescent dosimeters which are used when the exposure exceeds the limits of the film badge. These dosimeters may have several years of accrued exposures, but when their use is required the accrued exposure is normally only a small percent of the gamma-ray exposure indicated by the dosimeter.

The gamma-to-neutron ratio as a function of distance from the Jezebel assembly remains fairly constant when the assembly is outside the kiva, but when it is moved inside, the ratio becomes larger as the distance from the assembly is increased. The gamma-to-neutron ratios given in Table XVII are lower than those obtained for solution systems. Gamma-to neutron ratios up to 4 have been reported for solution systems,⁶ and higher values are possible with larger systems. The ratio of 0.049 obtained with the Flattop assembly is believed to be about the lowest obtainable. The neutron or gamma-to-neutron ratio could have a significant error, but an accuracy of $\pm 50\%$ should be obtainable for systems similar to those we studied if the distance from the person to the assembly is known.

Neutron Dose from Nuclear Track Films. The nuclear track neutron films used at LASL are calibrated in units of Rem. When the fast-neutron kerma exceeds ~ 3 hectoergs/

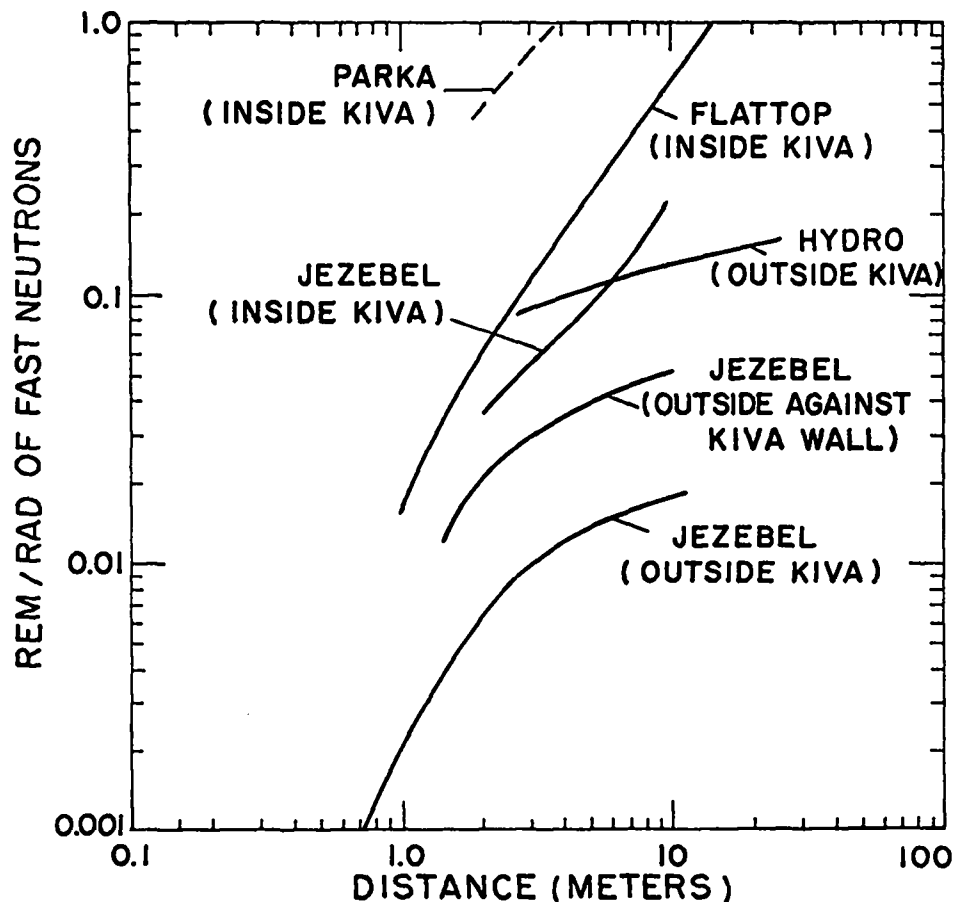

Fig. 19. Thermal-neutron dose equivalent determined by gold foils.

g, the film badges are blackened extensively by the accompanying thermal neutrons and gamma rays, and the nuclear track film can not be read. Dividing the dose equivalent obtained with the film badges by 10 converts to the approximate dose in rads.

The results from the nuclear track film badge would undoubtedly be low for systems having heavily moderated neutron spectra. The Flattop results, although not conclusive, indicate that this occurred. For low exposures to near-fission spectra, the results from film badges should be reasonably accurate.

Thermal-Neutron Dose Determined by Film Badges and Gold Foils. The thermal-neutron dose equivalent normalized to 1 hecto-erg/g of fast neutrons varied greatly as a

function of distance from the assembly (Fig. 19). The thermal-neutron dose makes only a small contribution to the total dose and was found to vary greatly for the different assemblies. The thermal-neutron dose is frequently ignored, or a statement is made that it is less than some small percent of the total dose. The footnote of Table XII indicates a factor of 11 difference between the first-collision absorbed dose and the maximum-absorbed dose. For the Parka assembly, which has the largest thermal-neutron component of the assemblies studied, the thermal neutrons contribute ~2% of the total first-collision absorbed dose and ~15% of the total maximum absorbed dose. The true absorbed dose is somewhere between these two values.

The film badges on the plastic men indicated consistently higher doses than did the gold foils or lithium iodide crystals. The film badges had been calibrated on a phantom prior to this study using the thermal-neutron flux from the Water Boiler reactor.¹⁹ The presence of fast- and intermediate-energy neutrons, which are insignificant in the beam of the Water Boiler reactor, may be responsible for the higher film badge readings observed with the critical assemblies.

Kerma Determination Using TDU Systems.

The fast-neutron dose was determined by using the Hurst proportional counter and the threshold detector units. The HPC cannot be used for burst but was used to confirm the accuracy of the TDU system. The variations in the dose determined by the HPC and the TDU system have been discussed. These variations were small for the near-fission spectra and became larger for the heavily moderated spectra. The larger variations were caused by the differences in the response of the two systems to lower-energy neutrons.

The fast-neutron dose as a function of distance from an assembly does not deviate greatly from the inverse-square relationship (see "Results"). Applying the inverse-square relationship over reasonable distances would cause only a small error in the calculated dose, or the deviation from the inverse-square relationship can be determined from the data given in Table VII. The effect on the TDU system of placing it on a concrete wall was not studied.

The dose determined by the fission-foil TDU system can be used to establish the dose received by a person quite accurately if he can establish his location and orientation at the time of the excursion. Because of the rapid decay of the fission pro-

ducts, the time lapse before the TDU system is recovered and counted must not exceed a few hours. The TDU method of dose determination is of primary value for a single burst, but if multiple bursts occur it can still be useful in establishing the approximate leakage-neutron spectrum.

Recently a number of TDU systems have been developed which do not contain the plutonium foil, and in some cases the neptunium and uranium foils are not used. These systems contain nonradioactive materials and are considerably less expensive to manufacture. None were evaluated in this study.

Dose Equivalent Determined by 10-In.-Sphere Neutron Detector. The 10-in.-sphere neutron detector was included in this study to determine the relative increase in the Rem over the kerma as a function of distance from the assembly. When the assemblies were outside the kiva, no increase was observed for the distances we studied, and only a slight increase was found with the assemblies inside.

The kerma used as the normalizing factor in Table XIV does not include the thermal-neutron or part of the intermediate-energy neutron dose. Further, the 10-in. sphere overresponds to intermediate-energy neutrons. The combined effect of these factors caused the Rem/hectoerg/g ratio to vary from 11 to 25, but the ratio for each assembly is constant within about $\pm 10\%$.

The 10-in.-sphere neutron detector is a count-rate instrument and therefore is not suited for dosimetry of bursts. In recent studies the electronic components of Rem-responding neutron instruments (Rem meters) have been replaced with passive detectors of gold with a tantalum shield,³⁷ or ⁶Li and ⁷Li thermoluminescent dosimeters.^{38,39}

The use of passive detectors makes these instruments useful as criticality dosimeters.

The 10-in. sphere with a passive detector is very accurate as a criticality dosimeter if a reasonable estimate of the Rem/hectoerg/g ratio is made. A neutron dose in kerma with an accuracy of ± 10 -15% for a known spectrum and ± 25 % for an estimated spectrum should be obtainable. A 10-in. sphere with a passive detector does not provide spectrum information and cannot be used when the approximate neutron spectrum at the unit locations is required.

Dose Equivalent Determined by the Multisphere Technique. The multisphere technique was included in this study for two purposes. The data were used to evaluate the neutron-activation probability for sodium in man (see Appendix A) and for a revision and accuracy evaluation of the multisphere technique.¹⁵ It is unlikely that the multisphere technique would be used in accident criticality dosimetry, but adequate information has been included to assist in the evaluation of the technique if it should be utilized.

Blood-Sodium Activation. The activation in a person's blood and hair may be the only dosimetry tool available if he was not wearing gamma and neutron dosimeters when the criticality accident occurred. Activation of hair^{33,34} is discussed in a later section.

Blood-sodium activation has been used to assist in the evaluation of the dose from most criticality accidents. Our results are plotted in Fig. 20 and indicate a large dependence on the leakage-neutron spectrum and distance from the assembly. Placing the assembly in the kiva or near its wall causes a significant increase in the blood-sodium activation. The results for unusual posi-

tions are given in "Exposures Occurring at Unusual Locations or Positions."

The accuracy of blood-sodium-activation determinations depends on the magnitude of the dose and on the neutron spectrum. For large doses and systems similar to the assemblies we studied, the dose can be estimated within ± 10 % if the distance from the assembly and other factors such as shielding, orientation, and assembly location with respect to floors and walls are known. For critical systems with known neutron spectra, that are not similar to the assemblies we studied, the uncertainty in the dose estimate may be ± 20 %. If the leakage spectrum must be estimated, ± 30 % may apply. For smaller doses a larger uncertainty would exist.

The large differences in blood-sodium activation per rad of fast neutron indicated in Fig. 20 are caused by the combination of two effects. First, the cross section of the body for sodium activation is relatively constant for all neutron energies. Therefore, the blood-sodium activation is approximately proportional to the number of neutrons incident on the body. Second, the dose per incident neutron is a function of neutron energy with higher energy neutrons delivering a larger dose. Thus the sodium activation per rad of incident neutrons from the Parka assembly, which has a large component of lower energy neutrons is higher than that obtained with Jezebel or Godiva.

The neutron activation probability for sodium in man was investigated. The probability curves published previously were inconsistent with our results. McGuire made calculations at this laboratory using a series of cylinders and elliptical right-cylinders of the approximate dimensions of the plastic men. The sodium activations obtained with the plastic men and the data from

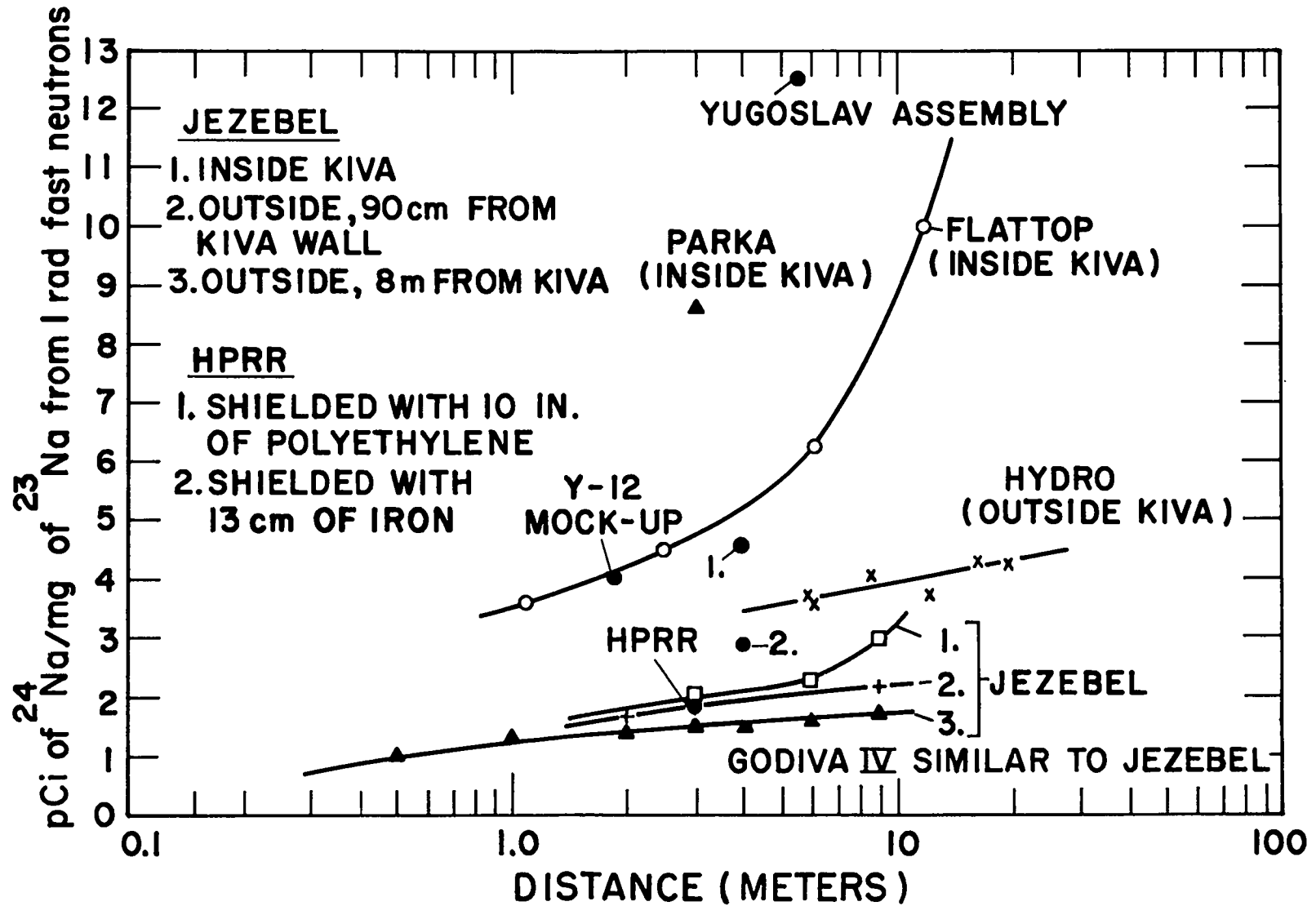

Fig. 20. Blood-sodium activation from 1 rad of fast neutrons.

the sphere neutron detectors were used to confirm the accuracy of the calculations. The results are given in Appendix A. McGuire gives probability curves that differ significantly from those used previously.

Vials containing 10 cc of the salt solution from the plastic men were analyzed for ^{24}Na , but for actual blood samples, 2 to 10 cc may be used. Whole blood contains 1.5 mg/cc, and the blood serum contains 3.2 mg/cc of ^{23}Na . The blood samples can be treated with heparin to prevent coagulation if a well crystal is not utilized in the analysis.

Sodium activation in the body can be determined for the lower doses by whole-body counting. Whole-body counting is a very useful tool and should be included in a dosimetry program if facilities are available. The effect of body weight on sodium activation must be considered in whole-body counting, and it is discussed in the next section of this report.

The ^{24}Na activity induced in the various segments of the plastic men is shown in Appendix B. The activation of the sodium in each segment of the plastic men was determined for about half of the irradiations. The effects of orientation, distance from the assembly, and neutron spectrum can be seen by the relative activation in the segments.

Weight of the Exposed Person. For the "fat man" irradiations a plastic bag was attached to the torso of the plastic man and formed to the contour of a heavy person by using tape. Unfortunately, the bag held only 8 liters of solution which increased the man's weight from 61.7 to 65.6 kg, a 6% increase. The results were essentially the same as those for the normal irradiations

except for an increase in the Geiger counter readings at the abdominal region. This increase occurred because the solution in the bag was not mixed with the solution in the body section of the plastic man. Appendix B shows the sodium activation in each body segment and in the plastic bag.

The neutron-activation probability for sodium in man¹¹ indicates that a 200-lb man has a higher capture probability than a 136-lb man (weight of plastic men) of ~19% for fast neutrons, ~8% for the intermediate energies, and ~5% for thermal neutrons. Also, the 200-lb man is ~30% larger than the 136-lb man. Thus, the larger person exposed to fast neutrons will have a total sodium activity ~55% greater than the smaller person. The activity in a blood sample from the larger man would be ~5% greater than that in the same volume of blood from the smaller man. For intermediate energy neutrons, the total activity in the larger person would be ~40% greater and the blood sample would have ~4% less activity. For thermal neutrons the differences are ~37% higher and ~7% lower, respectively. In most criticality excursions, neutrons of all energies would probably be present and the activity of a blood sample would be essentially independent of the weight of the person.

A correction for body weight must be applied to whole-body counting or the Geiger counter reading at the abdomen. The "Hanford Quick-Sort" dosimetry technique assumes that activation is proportional to body mass.³⁵ Using this assumption, a 200-lb person has 47% more sodium activity than a 136-lb person. This is in general agreement with the preceding paragraph, and could be applied with no significant error.

EXPOSURES OCCURRING AT UNUSUAL LOCATIONS OR POSITIONS

Exposures Occurring Near the Assembly.

The effects on the dosimetry caused by placing the plastic man very close to the assembly were smaller than expected. The thermal-neutron dose was found to be very small close to the assembly (Fig. 19), and the fast-neutron spectrum had a slightly higher average energy near the assembly (Tables X and XII). In spite of these spectral differences, the Geiger counter reading at the abdomen (Table XV) and the blood sodium activation (Fig. 20) were lower by <30% than the extrapolation value from the larger distances predicted. The indium foil (Table XV) and TLD (Table XVII) readings were low because they were more than 50 cm from the assembly (on the upper chest). For exposures occurring close to a critical system, the dose varies greatly over the various parts of the person. The personnel dosimetry packet may be nearer to or farther from the critical system than the average of the body, and a correction for distance may have to be applied to the dose determined from the packet.

Orientation with Respect to the Critical System. Dosimeters were placed on the front and back of the plastic men, and for three irradiations the plastic men were oriented sideways to the assembly. The results from the dosimeters have been discussed. The effect of orientation on blood-sodium activation has been studied by others,^{1,25,40} and our results do not differ significantly from their findings. Irradiations of the plastic men oriented sideways to the assemblies were made with the Jezebel, Hydro, and Parka assemblies, and the Na activations were 64, 72, and 74%, respectively, of those obtained from a facing position. The Jezebel

and Parka assemblies were selected to show differences that may be related to spectral changes.

The effect of orientation on the activation of foils is shown in the footnote to Table XV. Indium foils on the right and left breast of the plastic men gave Geiger counter readings which differed by a factor of ~2. The foil on the left breast was shielded by the chest, while that on the right breast was exposed to the assembly. The thermal-neutron doses measured by film badges on the front and back of the plastic man standing sideways to the irradiation from Jezebel differed greatly, indicating that the man was slightly rotated (Table XII). The gamma-ray dose determined with thermoluminescent dosimeters and film badges (Table XVII) was affected only slightly by this small change in orientation.

The gamma-ray dose determined with film badges and TLD's for the sideways irradiations was about 80% of that for the facing irradiation. The Geiger counter reading at the abdomen for the sideways irradiation averaged ~63%, and the indium foil readings were ~50% to 100%, of the readings for the facing irradiation.

When personnel neutron dosimeter packets are used to estimate the dose, the person's orientation with respect to the critical system must be known. Although personnel dosimetry packets containing sulfur pellets and copper foils were not used in this study, one investigator⁴¹ found that when they were placed on the back of a man-ikin, the activation was reduced by factors of 20 and 7, respectively. If the exposed person's orientation is not known, the dose estimates obtained by using the packets should be confirmed by other dosimetry techniques. The procedure described in "Dosime-

try Using Only Hair and Blood Activation" is independent of orientation and can be used if the orientation is unknown or known to be unfavorable for personnel dosimeters.

Shielding by Hydrogenous Material. One irradiation was performed with a plastic man 1 meter from the Jezebel assembly and a second plastic man directly behind him 2 meters from the assembly. The shielding afforded by the first man caused significant changes in the dose at 2 meters. The fast-neutron dose was decreased by a factor of ~ 5.5 , and the thermal-neutron dose was increased by a factor of ~ 2 . The 10-in.-sphere neutron detector and the multisphere technique gave doses that were increased by a factor of ~ 1.8 relative to the TDU system reading. Normalized to 1 rad of fast-neutrons, the blood-sodium activation, Geiger counter reading of the indium foil, and Geiger counter reading at the abdomen were higher by a factor of ~ 2 . The gamma-to-neutron ratio was higher by a factor of ~ 2 . Using the blood-sodium activation, the reading at the abdomen or reading of the indium foil would indicate that the person received twice his actual dose, and a correction would have to be applied.

Shown in Fig. 20 are results obtained from a nuclear accident dosimetry intercomparison study with the HPRR at Oak Ridge.⁴² The increased sodium activation obtained with the plastic man shielded by 10 in. of polyethylene is in general agreement with the findings given above.

The location at ~ 13 meters from the Flattop assembly was shielded by concrete. Since an unshielded location the same distance from the assembly was not studied, the effect of this shielding cannot be determined directly. A review of the results obtained at this location indicates that

the effects discussed above apply, although the magnitude can not be determined.

Shielding by Nonhydrogenous Material. Shielding by nonhydrogenous material was not included in this study; however, the Flattop assembly is essentially a Jezebel assembly shielded by 7 in. of ^{238}U which captures a large fraction of the neutrons of >1 -MeV energy. This is particularly noticeable when using the TDU system for which the neutron fluence (Table IX) and dose (Table X) calculated from the activations of the ^{238}U foils and sulfur pellets were very small. The Flattop assembly results can be applied to an accidental excursion if uranium shielding was involved.

The effect of iron shielding can be derived from the nuclear accident dosimetry intercomparison study at Oak Ridge⁴³ in which the plastic man was shielded from the HPRR by 13 cm of iron. The iron changed the neutron spectrum but did not cause the large enhancement of the neutrons in the 0.4- to 750-keV and thermal regions that was observed with the ^{238}U of the Flattop assembly. The blood-sodium activation per rad of fast neutrons (plotted in Fig. 20) for the unshielded radiations and those shielded with iron increased by $\sim 50\%$. The effect of lead and other materials was not studied.

Exposures with a Concrete Wall Behind the Plastic Man. Two positions in front of concrete walls were studied. The fast-neutron dose was $\sim 25\%$ higher than the dose at the same distance from the assembly without the concrete backing. The blood-sodium activation normalized to 1 rad of fast neutrons increased by $\sim 10\%$, and the gamma-ray-to-neutron ratio determined from film badges and TDL's placed on the backs of plastic men next to the wall increased by 5 to 30%. Gamma-ray film badges and TDL's on the front

of the plastic men were not affected by the concrete wall. The thermal-neutron fluence measured by gold foils in air was higher by a factor of ~ 2 than the dose without the concrete backing. The thermal-neutron dose determined from the film badges and indium foils on the backs of the plastic men was higher by a factor of ~ 3 .

Except for the thermal neutrons, a concrete wall behind a person will not greatly effect his dose or the dose calculated by using blood-sodium activation, film badges, or TDL's. Foils that are activated by thermal neutrons may show readings that are high by a factor of 3 if located between the man and the wall.

Critical Assembly Distance Above the Floor. The effect of scattering of neutrons and gamma-rays from the floor was studied by placing the Jezebel assembly outside 90 cm from the kiva wall. The kiva wall was assumed to be the floor, and the plastic man was laid on his side in a stretcher 2 meters from the assembly with his feet against the wall. Other irradiations were made with the man 3 and 9 meters from the wall and the assembly between the man and the wall. The results are plotted in Figs. 17 and 20 and are generally midway between those obtained outside and inside the kiva. The assembly-to-"floor" distance could not be decreased further because of the framework supporting the core, so only the 90-cm distance was studied. For smaller assembly-to-floor distances, the results would probably be similar to those obtained with the Jezebel assembly inside the kiva.

DOSIMETRY USING ONLY HAIR AND BLOOD ACTIVATION

After an accidental criticality excursion, information about what happened is usually not immediately available. The AEC

Manual, Chapter 0545 requires the use of fixed dosimetry stations and personnel dosimeters in areas where a criticality may occur. The fixed dosimetry systems are useful in ideal conditions, but of little or no value if the system cannot be recovered, if they were not in the area involved or were heavily shielded, or if more than one excursion occurred. The personnel dosimeters are of little value if the person's orientation with respect to the critical system at the time of the accident is not known.

We have said that the activation of blood sodium and hair is a strong function of neutron spectra. Thus, using either blood or hair activation alone subjects the dosimetry to large error. The dose can be determined with reasonable accuracy by using a ratio of the >2.9 -MeV neutron fluence to the blood-sodium activation. Table XVIII gives the ratios obtained.

The >2.9 -MeV neutron fluence was determined by 1-1/2-in.-diam sulfur pellets, but could have been determined by using the sulfur pellet in a personnel dosimetry packet or by hair activation analysis. The hair analysis would be used if sulfur pellets were not on the person, or if his orientation during the excursion was not known or resulted in shielding of the sulfur pellet in the personnel dosimeter. A procedure for the analysis of the hair activation is given in Reference 44.

Since the following procedure depends on a curve from experimental data obtained in this study, the >2.9 -MeV neutron fluence determined by sulfur must agree with the neutron fluence obtained using our calibration constants, or the curve must be revised to a different calibration. The cross sections we assumed for the calibration were given

TABLE XVIII.

RATIO OF >2.9-MeV FLUENCE TO BLOOD-SODIUM ACTIVATION
AND THE ERROR MADE BY USING THIS RATIO TO DETERMINE THE NEUTRON DOSE

Critical Assembly	Distance from Assembly (meters)	Sulfur Fluence (10^{10} n/cm ²)	Blood-Na Activation (10^{-6} μ c ²⁴ Na/mg ²³ Na)	Sulfur Fluence/Blood-Sodium Activation ($\times 10^{14}$)	Percent Error in Dose Determination by Using Curve of Fig. 19	
Jezebel (outside kiva)	0.5	4.9	47.4	1.03	- 5	
	1.0	1.4	17.2	0.81	+ 7	
	2.0	0.32	4.95	0.65	- 6	
	3.0	0.17	2.65	0.64	- 2	
	4.0	0.092	1.57	0.59	- 1	
	6.0	0.043	0.779	0.55	+ 6	
	8.0	0.022	0.461	0.48	+ 2	
	9.0	0.014	0.363	0.39	- 8	
	2.0 ^a	0.045	1.57	0.29	+10	
	7.7 ^a	0.024	0.598	0.40	+ 1	
	3.0 (fat man)	0.17	2.50	0.68	+ 3	
	3.0 (sideways)	0.17	1.70	1.00	-15	
	(inside kiva)	3.0	0.17	4.04	0.42	+22
		3.0 ^a	0.17	4.23	0.40	+12
		6.0	0.045	1.52	0.30	+11
9.0		0.018	0.907	0.20	- 1	
(outside kiva, 90 cm from wall)	2.0 ^a	0.40	7.46	0.54	+10	
	3.0	0.20	3.82	0.52	+25	
	9.0	0.027	0.593	0.46	+37	
Hydro	6.0	0.031	1.78	0.17	+ 2	
	6.0 ^a	0.031	2.01	0.15	+13	
	5.9	0.035	2.05	0.17	+17	
	8.7	0.015	0.973	0.15	+ 8	
	12.3	0.0077	0.528	0.15	- 1	
	16.2	0.0042	0.335	0.13	+ 4	
	19.8	0.0038				
	19.8 ^a	0.0034	0.278	0.12	-12	
	5.9 (fat man)	0.035	2.02	0.17	+15	
6.0 (sideways)	0.031	1.27	0.24	0		
Flattop	1.1	0.061	11.3	0.054	-61	
	3.0	0.012	2.10	0.057	-50	
	6.1	0.0030	0.985	0.030	-49	
	13 ^a	0.0026	0.789	0.033	-11	
Parka	3.0	0.031	6.03	0.051	+ 9	
	3.0 ^a	0.017	4.58	0.037	+1	
	3.0 (fat man)	0.031	6.52	0.048	+14	
	3.0 (sideways)	0.031	4.46	0.070	- 2	
Godiva IV (burst) (D.C.)	3.0	0.71	24.1	0.29	-15	
	3.0	0.73	25.1	0.29	-13	

a. These data were obtained at locations or positions which affect the results. Refer to Table VI.

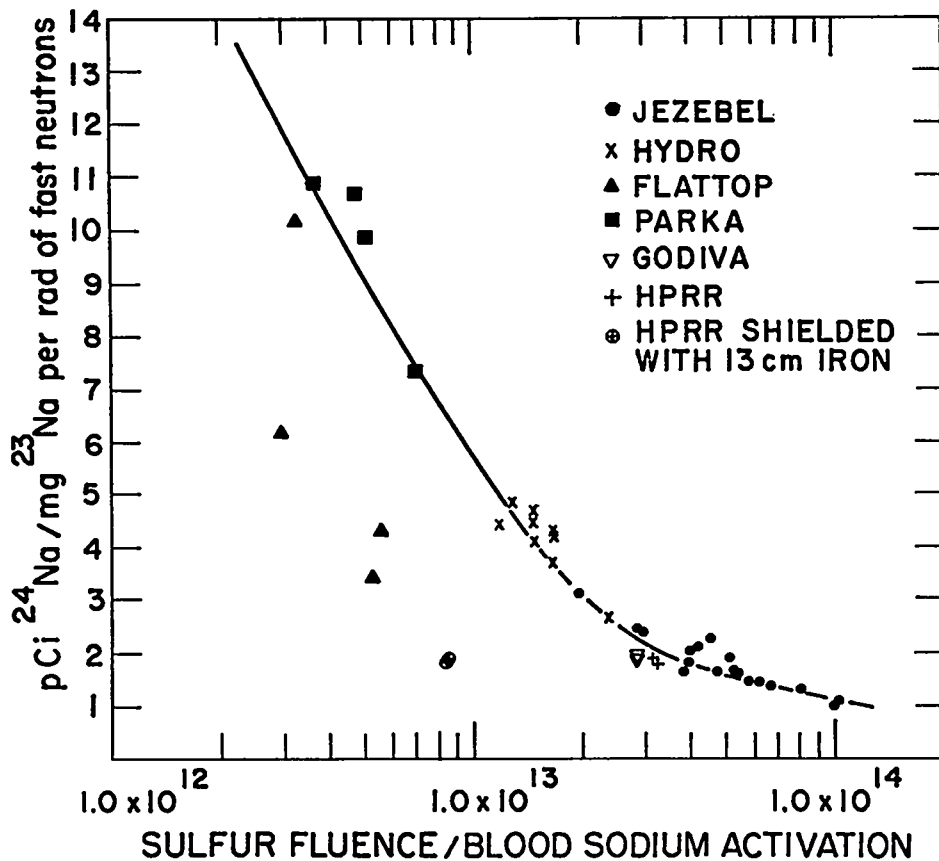

Fig. 21. Curve used to determine the neutron dose from blood-sodium and hair activation results.

in the section "Dosimetry Systems" and the effective cross section of sulfur is given in Table III. The latter cross-section values varied from 0.24 to 0.26 barn and may differ significantly from the values used elsewhere which range from 0.225 to 0.3 barn.

The blood-sodium determination requires a standard gamma-spectrometer calibration which should be accurate within a few percent. Relatively small neutron doses produce blood-sodium activations high enough to permit an accurate determination of the activation level. With low background counting equipment, a neutron dose of 0.28 rad can be determined from a 1-gram hair sample.⁸ Orientation can be determined by using several hair samples from different

parts of the body or around the head. The >2.9-MeV neutron fluence required for the procedure described below is the highest determined in the hair analysis procedure. (The enhanced activation, if any, caused by the hair being on a person should be included in the calibration).

The ratio of the neutron fluence determined by the sulfur pellets to the blood-sodium activation is plotted versus the blood-sodium activation per rad of fast neutrons in Fig. 21. Also shown are the results obtained in the nuclear accident dosimetry intercomparison study at the Oak Ridge National Laboratory.⁴³

The Flattop assembly (core surrounded by 7 in. of ²³⁸U) and the HPRR, shielded with 13 cm of iron, gave results that are

not consistent with those from the other assemblies. Because these assemblies were heavily shielded, they were not considered, and a curve was drawn through the remaining points.

The dose is determined by dividing the blood-sodium activation by the value obtained from Fig. 21 for blood-sodium activation per rad of fast neutrons. The error in calculating the dose is indicated in Table XVIII and is found to be >20% in only six cases, three of which were with the Flattop assembly. This technique calculated accurate doses for the irradiation in which the plastic man was turned sideways, was very close to the assembly (0.5 m), was placed in front of bulk shielding, and was shielded by a second plastic man. Why this procedure is accurate for all these orientations and locations is not definitely known. Bulk shielding of iron or ^{238}U causes the results to be low and depresses the >2.9-MeV neutron fluence (see Table IX) which causes the relative sulfur activity to be reduced when compared to unshielded irradiations. The curve in Fig. 21 apparently depends on a uniform moderation of the spectrum. The iron and uranium shielding causes a distorted spectrum, and the curve cannot be applied. The effect of hydrogenous materials has not been studied in detail, but the results obtained with the plastic man placed between the assembly and the second plastic man indicate that this effect is not found for hydrogenous materials.

This procedure for using blood-sodium and hair activation should permit an accurate determination of the dose a person received. The dose should be within ± 20 to 30% of the fast-neutron dose that would have been determined with a TDU system placed at that location. Orientation or

position does not affect the results when this procedure is used; however, the effect of partial body shielding was not studied. The dose determined by using a combination of blood-sodium and hair activations will be low if large amounts of iron or ^{238}U shielding are involved, but this is the only information required to make a reasonably accurate determination. An error in the >2.9-MeV neutron fluence or the ^{24}Na activation of the blood affects the dose evaluated with this technique by only about half the magnitude of the error; for example, a 25% error in the fluence causes $\sim 13\%$ error in the final results.

No gamma-ray exposure values are obtained by this technique. The gamma-ray dose would have to be determined from dosimeters or film badges or by applying a gamma-to-neutron ratio similar to those given in Table XVIII. The gamma-to-neutron ratio is very dependent on the type of critical system, and would require that information about the system be known.

CONCLUSIONS

Ideally several estimates of the dose the individual received should be obtained by different dosimetry techniques. Considerable information must be available before the dose received by personnel involved in an accidental criticality excursion can be accurately evaluated. It is very important that the location of the exposed personnel be established as accurately as possible and that other pertinent information such as orientation, shielding, and actions of the person following the excursion be obtained. A description of the critical system must be obtained to make an estimate of the leakage spectrum possible.

A technique for using a combination

of the blood-sodium and hair activation was developed during this study and seems to give accurate dose estimates. It does not require the large amount of information necessary for other types of personnel dosimetry, permits an estimate of the person's dose to be made within a few hours, and does not require placing of personnel dosimeters on the person.

ACKNOWLEDGMENTS

The author expresses special thanks to Raymond Pederson and Harry Craig for their assistance in obtaining the large amount of data required in this study. Appreciation is expressed to Dr. Hugh Paxton, Group Leader of N-2, for his cooperation in making the critical assemblies available for the time necessary to perform the irradiations.

APPENDIX A

PROBABILITY OF NEUTRON CAPTURE BY SODIUM IN THE BODY

The probability of neutron capture by sodium was originally given by Hurst, Ritchie, and Emerson⁵ and later by Hurst and Ritchie.¹ More recently, curves by Auxier, Sanders, and Snyder,⁴⁵ and Snyder⁴⁶ have appeared. An experimental evaluation has been performed by Smith⁹ using 0.2-, 0.5-, 2.5- and 6.25-MeV neutrons from an accelerator. Because of the discrepancy between Smith's data and the more recent curves given above, Oak Ridge National Laboratory has undertaken a study similar to Smith's to recalculate the curves of probability of neutron capture based on an improved Na cross section.⁴⁷ The Oak Ridge study indicates that Smith's

data may be slightly high (owing to an underestimate of the error caused by the polyethylene containers) and that the calculations using the new Na cross section will give better agreement with Smith's revised values.

A series of calculations of the probability of neutron capture by sodium was made at LASL using a cylinder of 30-cm diam and 60- or 100-cm high. Figure A-1 shows the sodium activation per neutron vs energy for a 30-cm-diam, 100-cm-high cylinder. A 100-cm-high cylinder has a total volume of $\sim 7.0 \times 10^4$ cc which is similar to the standard man. Calculation using a 30 by 60 cm phantom indicated 5% less activation for the neutrons of >100 -keV energy; below 100 keV they agreed within 1%. The curve in Fig. A-1 is

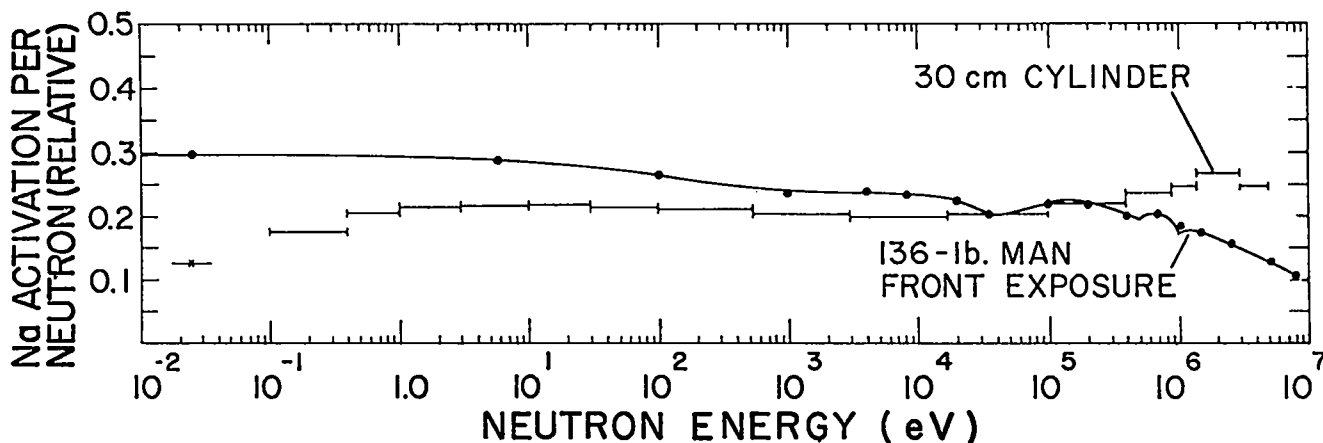

Fig. A-1. Neutron capture probability vs neutron energy.

for the International Commission of Radiological Protection (ICRP) recommended tissue composition,⁴⁸ and a sodium concentration of 0.15% was used to give 105 grams total sodium (standard for a 70-kg man).

The neutron-capture probability curve of the cylinder is compared in Fig. A-1 to the capture probability curve obtained by McGuire¹¹ using a geometry more closely approximating that of a man. This consisted of a number of finite cylinders as shown in Fig. A-2. The sizes of the various segments of the man were adjusted to give a total weight of 136 lb which is the weight of the plastic men used in this study when they are filled with saline solution. The standard man composition recommended by the ICRP was used in the calculations. The two capture probability curves differ significantly.

Data were obtained with the sphere neutron detectors to try to determine the approximate shape of the probability curve which applies to the plastic men. The 3- and 8-in. spheres were used without the cadmium cover normally employed. Data were also obtained with the bare probe, cadmium-covered probe, and cadmium-covered 2-, 3-, and 8-in. spheres. The count rates from the sphere detectors were added using a number of possible combinations, and the total was compared to the magnitude of the sodium activation observed in the plastic men. The results of one of these combinations are shown in Table AI. This combination of 1.5 times the count obtained with the 3-in. sphere without the cadmium cover added to the count obtained with the 8-in. sphere without cadmium, gave the best fit to the sodium activation observed in the plastic men.

The curve obtained with this combination has been calculated in Table AII and plotted in Fig. A-3 by normalizing at 50 keV

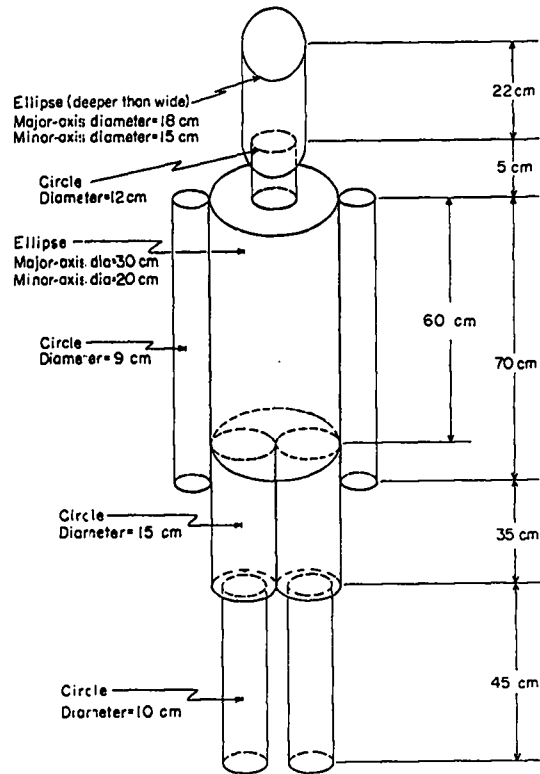

Fig. A-2. Representation of 136-pound man for Monte Carlo computations.

to the capture probability curve for the 136-lb man. The comparison between the sphere response curve and the capture probability curve shown in Fig. A-3 is very good except near the thermal regions. Attempts to obtain a better agreement by adding part of the thermal response (bare probe minus cadmium-covered probe) resulted in a larger deviation from the sodium activation actually observed. The absorption of the thermal neutrons by the lucite skin of the plastic men does not produce sodium activation in the saline solution, and is probably responsible for the drop in the probability curve at the thermal region.

The general agreement in Fig. A-3 between the sphere response curve and the capture probability curve of a man indicates that the capture probability curve calculated by McGuire is reasonably accurate. Cal-

TABLE AI.

COUNT RATE OF THE 3- AND 8-INCH SPHERES
COMPARED TO THE OBSERVED ^{24}Na ACTIVATION

Critical Assembly	Distance from Assembly (meters)	3-in. Sphere Without cd (cpm)	8-in. Sphere Without cd (cpm)	1.5 x 3 in. (cpm)	(1.5 x 3 in.)+8 in. 1.0058×10^5 (cpm)	20 Min. Irradiation	Percent Deviation	
						$\mu\text{Ci } ^{24}\text{Na}/\text{mg } ^{23}\text{Na}$ ($\times 10^{-3}$)		
Jezebel (outside kiva)	0.5	1,162,000	4,844,000	6,587,000	66.3	47.4	+40	
	1.0	323,500	1,256,000	1,741,000	17.5	17.2	+ 2	
	2.0	103,400	365,100	520,200	5.23	4.95	+ 6	
	3.0	62,810	187,400	281,600	2.83	2.65	+ 7	
	4.0	37,660	88,790	145,300	1.46	1.57	- 7	
	6.0	19,320	48,910	77,890	0.783	0.779	0	
	8.0	11,560	28,220	45,560	0.458	0.461	- 1	
	9.0	9,677	24,000	38,520	0.387	0.363	+ 7	
	7.7 ^a	22,720	43,750	77,830	0.783	0.598	+31	
	3.0 (fat man)	62,810	187,400	281,600	2.83	2.50	+13	
	(inside kiva)	3.0	108,000	185,800	347,800	3.50	4.04	-13
		3.0 ^a	115,500	214,500	387,800	3.90	4.23	- 8
		6.0	55,970	70,840	154,800	1.56	1.52	+ 3
		9.0	35,800	35,530	89,230	0.898	0.907	- 1
	(outside kiva, 90 cm from wall)	2.0 ^a	183,600	434,300	709,700	7.14	7.46	- 4
3.0		93,400	178,600	318,700	3.21	3.82	-16	
9.0		18,360	32,070	59,610	0.60	0.593	+ 1	
Hydro	6.0	63,900	86,170	182,020	1.83	1.78	+ 3	
	6.0 ^a	71,090	91,900	198,500	2.00	2.01	0	
	5.9	70,860	102,000	208,300	2.10	2.05	+ 2	
	8.7	33,550	45,460	95,790	0.963	0.973	- 1	
	12.3	18,430	23,900	51,540	0.518	0.528	- 2	
	16.2	12,080	13,680	31,800	0.320	0.335	- 4	
	19.8	7,923	8,883	20,760				
	19.8 ^a	12,450	12,200	30,880	0.310	0.278	+11	
	5.9 (fat man)			208,300	0.210	2.02	+ 4	
	Flattop	1.1	376,000	550,000	1,114,000	11.2	11.3	- 1
3.0		85,580	82,690	211,100	2.12	2.10	+ 1	
6.1		48,230	34,550	106,900	1.08	0.985	+10	
6.1 ^a						0.789		
Parka	3.0	590,700	313,300	1,199,000	12.06	12.06	0	
	3.0 ^a	449,000	233,500	907,000	9.12	9.16	0	
	3.0 (fat man)				12.06	12.00	+ 1	
Godiva IV (burst) (D.C.)	3.0							
	3.0							

a. These data were collected at locations or positions which affect the results. Refer to Table VI.

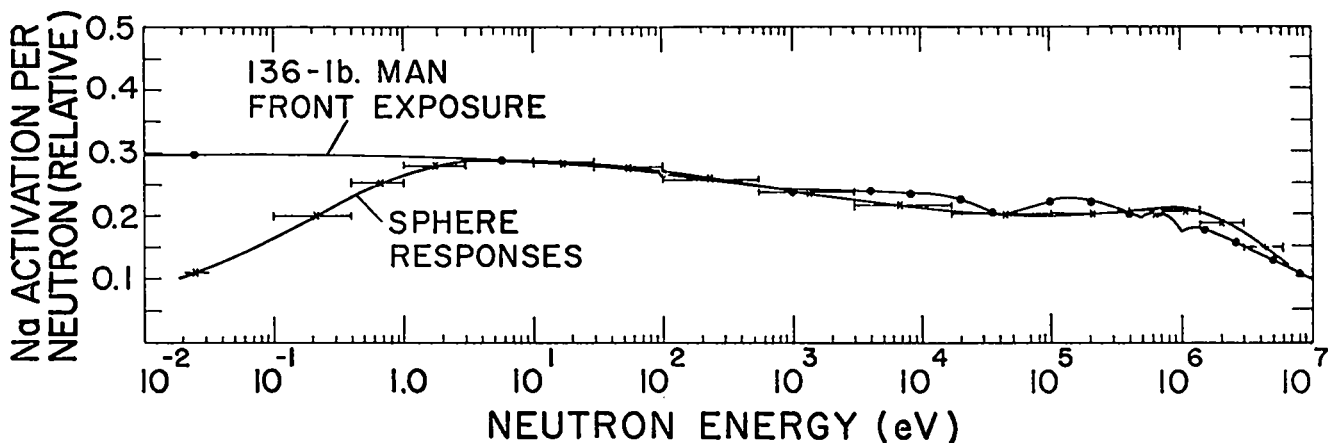

Fig. A-3. Comparison of results using 3- and 8-in. spheres with the capture probability of a man.

TABLE AII.

RELATIVE EFFICIENCY OF 3- AND 8-IN. SPHERES
TO THAT OBTAINED USING 1.5 TIMES THE 3-IN.
SPHERE PLUS THE 8-IN. SPHERE

<u>3-in. Sphere Efficiency</u>	<u>8-in. Sphere Efficiency</u>	<u>(1.5 x 3-in.) +8-in. Sphere Efficiency</u>	<u>Energy</u>
			<u>MeV</u>
0.0001	0.0068	0.0070	96-192
0.0004	0.0210	0.0216	48-96
0.0014	0.0523	0.0544	24-48
0.0034	0.0916	0.0967	12-24
0.0087	0.1533	0.166	6-12
0.017	0.2286	0.255	3-6
0.033	0.2720	0.322	1.4-3
0.055	0.2711	0.354	0.9-1.4
0.078	0.2386	0.356	0.4-0.9
0.112	0.1792	0.347	0.1-0.4
			<u>keV</u>
0.147	0.1236	0.345	17-100
0.178	0.1023	0.369	3-17
0.209	0.0914	0.405	0.55-3
			<u>eV</u>
0.240	0.0825	0.443	100-550
0.267	0.0738	0.475	30-100
0.282	0.0670	0.490	10-30
0.288	0.0599	0.492	3-10
0.284	0.0527	0.479	1-3
0.260	0.0442	0.434	0.4-1.0
0.205	0.0333	0.341	0.1-0.4
0.114	0.0171	0.188	thermal

culations of the capture probability of a 200-lb man are also given by McGuire.¹¹ The differences between these capture probab-

ility curves and their effect on the results given in this report are discussed further in "Weight of the Exposed Person."

APPENDIX B

SODIUM ACTIVITY INDUCED IN VARIOUS SEGMENTS OF THE PLASTIC MEN

The sodium activity in the various segments of the plastic men for most of the irradiations for which the assembly-to-plastic man distances were small is given in Table BI. These activities have been corrected for concentration and skin effects.

The effects of the different leakage-neutron spectra can be seen by comparing the sodium activity in the head and upper torso with that in the lower leg segments. For the spectrum from the Jezebel assembly (inside kiva), the activity in the legs was about two-thirds that in the head and upper torso, but for the heavily moderated spectrum of the Parka assembly, they were essentially equal.

The sideways irradiations decreased the sodium activation in the shielded arm by factors of 3 and 4 for the Hydro and Parka assemblies, respectively. Placing the assemblies inside the kiva increased the relative activation of the extremities above that observed outside the kiva.

The sodium activations obtained with the plastic man 50 cm from the assembly decreased in the head and upper torso and the lower legs compared to the activity obtained at greater distances from the assembly. This decrease was caused by the increased distance to these segments. The lower arms, which were placed very close to the assembly and received a much higher relative dose, had about the same relative activity compared to the composite as that obtained when the plastic man was 3 meters from the assembly with his hands at his sides.

The solution in the plastic bag which was placed on the front of the plastic man to obtain the "fat man" data had activity levels significantly higher than those in the lower torso. This increase was 1.6 for Jezebel, 1.9 for Hydro, and 3.8 for Parka. These differences were caused by the thermal, intermediate-energy, and lower-energy fast neutrons which cause activation near the surface. The Parka spectrum contains a large thermal and intermediate-energy neutron component, and, consequently, much of the activation occurred in the plastic bag.

Table BI. ²⁴Na Concentrations in Plastic Man Segments

Assembly, Distance from Assembly, Position of Plastic Man	²⁴ Na Concentrations (Ci ²⁴ Na/mg ²³ Na/rad) x 10 ⁶											Gonads	Plastic Bag Fat Man
	Total Man	Head and Upper Torso	Lower Torso	Upper Right Arm	Upper Left Arm	Lower Right Arm	Lower Left Arm	Upper Right Leg	Upper Left Leg	Lower Right Leg	Lower Left Leg		
Hydro 6.0 m beside another plastic man ^a	3.76	4.25	4.08	3.55	4.41	2.74	3.21	3.25	3.44	2.17	2.47		
Hydro 6.0 m beside another plastic man ^b	3.66	4.12	3.91	4.08	3.80	3.52	2.83	3.27	3.04	2.63	2.36	3.09	
Hydro 6.0 m sideways ^a	2.65	3.05	2.31	3.81	1.00	2.89	1.04	4.12	1.78	2.71	1.81		
Hydro 6.0 m ^a	3.71	4.15	4.04	3.88	4.06	3.13	3.03	3.42	3.13	2.40	2.55	3.23	
Hydro 5.9 m elevated ^a	4.27	4.51	4.89	4.19	4.47	3.49	3.29	3.99	3.79	2.75	2.81		
Hydro 5.9 m fat man elevated ^a	4.21	4.75	3.30	4.13	4.69	3.79	3.55	4.13	3.89	3.34	3.28	3.65	6.18
Jezebel inside kiva 3 m ^a	2.01	2.00	2.37	1.72	1.81	1.46	1.36	1.98	1.91	1.35	1.40	1.58	
Jezebel outside 2 m ^a	1.41	1.44	1.88	1.10	1.20	0.80	0.77	1.28	1.22	0.67	0.68	0.96	
Jezebel outside 1 m ^a	1.32	0.99	1.92	0.91	0.95	0.81	0.68	1.28	1.20	0.43	0.47	0.99	
Jezebel outside 50 cm ^a	1.03	0.44	1.70	0.37	0.48	0.86	0.67	1.10	1.00	0.25	0.27	1.02	
Jezebel outside 3 m fat man ^a	1.39	1.32	1.36	1.10	1.12	0.95	0.82	1.35	1.33	0.75	0.80	0.97	2.19
Jezebel outside 3 m ^b	1.47	1.45	1.90	1.22	1.31	0.98	0.92	1.34	1.35	0.88	0.83	1.11	
Jezebel 90 cm from Kiva wall 2 m lying on side ^a	1.66	1.43	2.07	1.18	1.42	1.05	1.04	1.82	1.79	1.10	1.17	1.27	
Flattop 110 cm right arm on platform ^a	3.42	4.91	4.31	4.31	4.37	3.36	2.02	1.45	1.40	1.24	1.18		
Parka 3 m elevated ^b	9.88	9.70	9.86	12.0	10.2	10.6	10.8	9.48	9.13	8.88	9.04	13.2	
Parka 3 m elevated fat man ^b	9.83	10.7	6.41	11.3	13.0	11.8	12.2	10.0	10.5	10.4	10.4	14.7	18.2
Parka 3 m elevated sideways ^b	7.31	7.44	4.89	14.6	3.22	13.2	3.90	12.5	4.21	11.4	5.53	4.55	
Godiva buret 3 m ^b	1.90	1.93	2.25	1.75	1.73	1.53	1.32	1.95	1.83	1.56	1.42		

^a Plastic man with skeleton.^b Plastic man with organs.

REFERENCES

1. G. S. Hurst and R. H. Ritchie, "Radiation Accidents: Dosimetric Aspects of Neutron and Gamma-ray Exposures," Oak Ridge National Laboratory Report ORNL-2748 Pt. A, 1959.
2. Payne S. Harris, "Acute Radiation Death Resulting from an Accidental Nuclear Critical Excursion: Dosimetric Calculations," *J. Occup. Med.*, 3, 178-183 (1961).
3. Joseph G. Hoffman, "Radiation Doses in Pajarito Accident of May 21, 1946," Los Alamos Scientific Laboratory Report LA-687, 1948.
4. F. S. Patton (Chairman of Investigating Committee), "Accidental Radiation Excursion at the Y-12 Plant, June 16, 1958, Final Report," Union Carbide Nuclear Company, Y-12 Plant Report Y-1234, 1958.
5. G. S. Hurst, R. H. Ritchie, and L. C. Emerson, "Accidental Radiation Excursion at the Oak Ridge Y-12 Plant-III. Determination of Radiation Doses," *Health Phys.*, 2, 121-133 (1959).
6. G. S. Hurst et al., "Dosimetric Investigation of the Yugoslav Radiation Accident," *Health Phys.*, 5, 179-202 (1961).
7. "Hanford Report: Dosimetry Investigation of the Recuplex Criticality Accident," *Health Phys.*, 9, 757-768 (1963).
8. H. M. Parker and C. E. Newton, Jr., "The Hanford Criticality Accident: Dosimetry Techniques, Interpretations and Problems," Personnel Dosimetry for Radiation Accidents, Proceedings of a Symposium on Personnel Dosimetry for Accidental High-Level Exposure to External and Internal Radiation, IAEA, Vienna, 567-582, 1965.
9. J. W. Smith, "Sodium Activation by Fast Neutrons in Man Phantoms," United Kingdom Atomic Energy Authority Research Group Report AERE-R 3697, 1962.
10. W. S. Snyder, "Estimation of Dose Distribution Within the Body from Exposures to a Criticality Accident," in Selected Topics in Radiation Dosimetry, Proceedings of a Symposium, IAEA, Vienna, p. 647, 1961.
11. S. A. McGuire, "Neutron Activation Probability for Sodium in Man," Los Alamos Scientific Laboratory Report LA-3721, 1966.
12. H. H. Rossi, Chairman, et al., National Committee on Radiation Protection and Measurement, Subcommittee 4, Protection Against Neutron Radiation up to 30 Million Electron Volts, National Bureau of Standards Handbook 63, 1957.
13. G. A. Jarvis, G. A. Linenberger, J. D. Orndoff, and H. C. Paxton, "Two Plutonium-Metal Critical Assemblies," *Nucl. Sci. Eng.*, 8, 525-531 (1960).
14. W. U. Geer, P. G. Koontz, J. D. Orndoff, and H. C. Paxton, "Hazards Evaluation for the Los Alamos Critical Assembly Facility," Los Alamos Scientific Laboratory Report LAMS-2698 Rev., 1962.
15. Dale E. Hankins and G. E. Hansen, "Revised Dose Estimates for the Criticality Excursion at Los Alamos Scientific Laboratory, May 21, 1946," Los Alamos Scientific Laboratory Report LA-3861, 1967.
16. G. E. Hansen, Los Alamos Scientific Laboratory, unpublished data, 1966.
17. C. W. Watson, Los Alamos Scientific Laboratory, unpublished data, 1966.
18. J. N. P. Lawrence, unpublished report, "Emergency Procedures for Nuclear Accidents," Los Alamos Scientific Laboratory, 1968.
19. Ellery Storm and Simon Shlaer, "The Development of Film Badges Containing Multi-Element Filters to Reduce the X-Ray Energy Dependence of Photographic Film," Los Alamos Scientific Laboratory Report LA-3001, 1961.
20. Edwin A. Bemis, "Status and Application of Thermoluminescent Dosimetry Systems," in Proceedings of 10th Annual Bio-assay and Analytical Chemistry Meeting, Cincinnati, Ohio, Atomic Energy Commission Report Conf-727, 1964.
21. Dale E. Hankins, "The Multisphere Neutron-Monitoring Technique," Los Alamos Scientific Laboratory Report LA-3700, 1968.
22. Dale E. Hankins, "A Neutron Monitoring Instrument Having a Response Approximately Proportional to the Dose Rate from Thermal to 7.0 MeV," Los Alamos Scientific Laboratory Report LA-2717, 1962.

23. Dale E. Hankins, "New Methods of Neutron-Dose-Rate Evaluation," Neutron Dosimetry Proceedings of an IAEA Symposium, Harwell, Vol. II, 123-139, 1962.
24. Roland E. Davis, Los Alamos Scientific Laboratory, personal communication, 1958.
25. D. R. Davy, L. H. Peshori, and J. W. Poston, "Sodium-24 Production in Saline-Filled Phantoms Under Neutron Irradiations," Health Phys., 12, 1353-1355 (1966).
26. G. S. Hurst, "An Absolute Tissue Dosimeter for Fast Neutrons," Brit. J. Radio., 27, 353 (1954).
27. R. D. Jones, D. R. Johnson, and J. H. Thorngate, "Neutron Dose Conversion Factors for PuBe and PoBe Sources," Health Phys., 11, 519-522 (1965).
28. P. W. Reinhardt and F. J. Davis, "Improvements in the Threshold Detector Method of Fast-Neutron Dosimetry," Health Phys., 1, 169 (1958).
29. D. R. Johnson, J. H. Thorngate, P. W. Reinhardt, and F. J. Davis, "An Experimental Calibration of Fission Foil Threshold Detectors," Health Phys., 11, 759-762 (1965).
30. Merle E. Bunker, "Status Report on the Water Boiler Reactor," Los Alamos Scientific Laboratory Report LA-2854, 1963.
31. H. O. Syckoff, Chairman, International Commission on Radiological Units and Units and Measurement (ICRU), "Radiation Quantities and Units," National Bureau of Standards Handbook 84, 1962.
32. L. L. Anderson, R. L. Duffy, J. Sidlet, and D. P. O'Neil, "Nuclear Accident Dosimetry at Argonne National Laboratory," Personnel Dosimetry for Radiation Accidents, Proceedings of an IAEA Symposium, Vienna, 645-663, 1965.
33. D. F. Petersen, V. E. Mitchell, and W. H. Langham, "Estimation of Fast Neutron Doses in Man by $^{32}\text{S}(n,p)^{32}\text{P}$ Reaction in Body Hair," Health Phys., 6, 1-5 (1961).
34. D. F. Petersen and W. H. Langham, "Neutron Activation of Sulfur in Hair: Application in a Nuclear Accident Dosimetry Study," Health Phys., 12, 381-384 (1966).
35. R. H. Wilson, "A Method for Immediate Detection of High Level Neutron Exposure by Measurement of Sodium-24 in Humans," Hanford Atomic Products Operation Report HW-73891 Rev., 1962.
36. Roger Estournel, Philippe Henry, Paul Beau, and Alain Ergas, "Evaluation Rapide de la Dose de Neutrons a la Suite d'un Accident de Criticite par Mesure de L'activite de ^{24}Na ," Commissariat a L'Energie Atomique Report CEA-R 3083, 1966.
37. S. Block, "An Energy-Independent Foil Activation System for Rapid Assessment of Pulsed Neutron Dose," in Laboratory Report UCRL 50007-66-2, 1966.
38. K. O'Brien, R. Sanna, and J. McLaughlin, "Inference of Accelerator Stray Neutron Spectra from Various Measurements," Proceedings of the USAEC First Symposium on Accelerator Radiation Dosimetry and Experience, Upton, N. Y., Atomic Energy Commission Report Conf-651109, 286-305, 1965.
39. J. E. McLaughlin and K. O'Brien, "Accelerator Stray-Neutron Dosimetry: Spectra of Low- and Intermediate-Energy Neutrons," Neutron Monitoring, Proceedings of a Symposium, Vienna, 335-354, 1966.
40. J. W. Smith, S. J. Boot, and J. A. Dennis, "A Criticality Dose Assessment System," in Personnel Dosimetry for Radiation Accidents, Proceedings of an IAEA Symposium, Vienna, 369-389, 1965.
41. P. Candès et J. M. Lavie, "La Dosimétrie des Radioexpositions Accidentelles Externes au Commissariat à L'Énergie Atomique," in Personnel Dosimetry for Radiation Accidents, Proceedings of an IAEA Symposium, Vienna, 607-622, 1965.
42. J. A. Auxier et al., "Nuclear Accident Dosimetry Intercomparison Study," in Health Physics Division Annual Progress Report for Period Ending July 31, 1966, Oak Ridge National Laboratory Report ORNL-4007, 1966.
43. J. A. Auxier et al., "Third Annual Intercomparison Study," in Health Physics Division Annual Progress Report for Period Ending July 31, 1967, Oak Ridge National Laboratory Report ORNL-4168, 1967.

44. D. F. Petersen, "Rapid Estimation of Fast-Neutron Doses Following Radiation Exposure in Criticality Accidents: the $^{32}\text{S}(n,p)^{32}\text{P}$ Reaction in Body Hair," in Personnel Dosimetry for Radiation Accidents, Proceedings of an IAEA Symposium, Vienna, 217-234, 1965.
45. J. A. Auxier, F. W. Sanders, and W. S. Snyder, Radioactivity in Man, G. R. Meely, Ed., Charles C. Thomas, Springfield, Ill., 1961, p. 201.
46. W. S. Snyder, "Estimation of Dose Distribution Within the Body from Exposure to a Criticality Accident," in Selected Topics in Radiation Dosimetry, IAEA, Vienna, 647, 1961.
46. R. D. Jones, "Body Sodium Activation as a Dosimetric Tool in Nuclear Accidents," in Health Physics Division Annual Progress Report for Period Ending July 31, 1965, Oak Ridge National Laboratory Report ORNL-3849, 1945.
48. Report of ICRP Committee, Health Phys., 3, 146 (1960).